

lineabeta<sup>®</sup>

---

25



---

## BELLO E QUOTIDIANO / *BEAUTIFUL AND EVERYDAY*

---

*Se dovessi augurarmi un futuro o lo dovessi augurare a mio figlio lo vorrei sereno. Sereno non è felice per forza. Sereno è senza preoccupazioni non necessarie. Che poi alla fine sono solo poche quelle che contano davvero. Sereno è semplice e senza sforzo. Sereno è bello senza complicazioni o sovrastrutture. Sereno è un cielo di Monet e una sedia Bauhaus o una casa sulla cascata di Frank Lloyd Wright. Ma anche uno spremiagrumi di Starck o una tv Brionvega Algol di Zanuso e Sapper. Sereno è meglio di felice perchè dura, bello e pratico è meglio che utile e basta, perchè è nel giornaliero che trova senso la nostra esistenza. Fatta di attimi e gesti e che spesso dimentichiamo nel perseguire grandi progetti, scorrendo che la vita è fatta dai mattoncini del vivere quotidiano. E se non stabiliamo, come tutte le civiltà hanno tentato di fare, che la ricerca del bello è essenziale vivremo nell'approssimazione del provvisorio, solo pratico e senza anima.*

Sebastiano Zanolli

*If I have to wish a future for myself and if I have to wish it upon my son, I would wish for serenity. To be serene is not to necessarily be happy. To be serene is to live without unnecessary worries. Which in the end, only a few of them really count. To be serene is to be simple, without effort. To be serene is beautiful without complications or intricacies. To be serene is a sky by Monet and a chair by Bauhaus or Frank Lloyd Wright's Fallingwater house. Yet also a Starck citrus squeezer or a Brionvega Algol TV by Zanuso and Sapper. Being serene is better than being happy because it lasts, to be beautiful and practical is better than to only be useful, because our existence finds meaning in everyday life. It is made of moments and gestures that we often forget as we pursue greater projects, no longer remembering that life is made of the bricks of everyday life. And if we don't establish, as all civilisations have tried to do, that the quest for beauty is essential, we will live in the approximation of transience, practicality and without soul.*

Sebastiano Zanolli

Parlare di design rispetto alle idee, ai prodotti, a noi stessi, diventa fondamentale se riconosciamo che questo mercato ha più offerta che domanda. Il design, l'estetica, diventano allora un elemento altamente differenziante e soprattutto facile da comprendere. "Design" vuole dire progettazione e indica le azioni di conoscenza, di metodo, e gli strumenti di ricerca ed ideazione finalizzati alla realizzazione di un qualsiasi prodotto o servizio. Ma è ora di comprendere che nella società globalizzata il design diventa un linguaggio universale che supera idiomi e pregiudiziali. È l'apoteosi del pensiero della Bauhaus. Produrre oggetti di design a basso costo perché siano fruibili dalle masse. Tutti ora possiamo e dobbiamo puntare al design per distinguerci dall'indistinguibile. Tenere conto del design in ogni occasione in cui state progettando qualcosa... è un modo per migliorare il mondo a partire dal di fuori, oltre che offrire delle possibilità alle nostre iniziative. Se, come afferma Stefano Zecchi (Ordinario di Estetica presso l'Università degli Studi di Milano) "...la vera sfida è sempre stata quella di gareggiare in bellezza con la natura... costruire cose belle che non offendano il paesaggio...", avere senso ed attenzione per il bello rende il mondo migliore.

**Sebastiano Zanolli**

Io, società a responsabilità illimitata  
Ed. Franco Angeli 2008

To talk about design in terms of ideas, products, ourselves, becomes essential if we recognise that this market has more offer than demand. This is when the design, the aesthetics, becomes a highly differentiating element, and above all easy to understand. "Design" means developing and indicates the actions of knowledge, method and the tools for research and concept aimed at building whatever product or service. But it is now time to understand that in the globalised society design becomes a universal language that goes beyond language and prejudices. It is the apotheosis of Bauhaus's philosophy. To produce low-cost design objects so that they can be available to the masses. Now we all can and must focus on design to distinguish ourselves from the indistinguishable. Taking design into account every time you work on something... is a way of improving the world starting from the outside, in addition to offering possibilities to our initiatives. If, as Stefano Zecchi claims (Professor of Aesthetics at the University of Milan) "...the true challenge has always been to compete with the beauty of nature... to build beautiful things that do not ruin the landscape...", having a sense of and attention to what is beautiful makes the world better.

Sebastiano Zanolli

*A passage from the chapter on design from  
"Io, società a responsabilità illimitata" (Me, an unlimited liability company)*

---

## CHI SIAMO / WHO WE ARE

---



Fresca, giovane, colorata, adattabile, accessibile, ironica, democratica, unconventional ma semplice al tempo stesso: questa è Lineabeta.

Il claim “everyday design” mette l’accento sul percorso che l’azienda ha intrapreso già da qualche tempo, senza soluzione di continuità con gli ultimi trenta anni di storia aziendale: un’idea di ambiente bagno flessibile, comodo e funzionale, dove vivere la quotidianità in modo semplice e spontaneo.

Quelli ritratti nel nuovo catalogo sono luoghi “reali”. Lineabeta è entrata in spazi pubblici e privati, distinti per stile, gusto e funzione, ma sempre strettamente legati alla vita di tutti i giorni.

Abbiamo gettato uno sguardo sull’intimità di persone diverse, dall’imprenditore innamorato del classico, al dj eccentrico, all’artista eclettico, alla giovane coppia con bambino, all’illustratrice fantasiosa scoprendo come ciascuno vive il prodotto Lineabeta a proprio modo, reinterpretandolo a volte, per comprendere alla fine che ciascuno nel proprio spazio vuole sentirsi bene, sentirsi a casa.

*Fresh, young, colourful, adaptable, accessible, ironic, democratic, unconventional yet simple at the same time: this is Lineabeta.*

*The claim “everyday design” places the accent on the direction that the company decided to undertake some time ago, all the while staying in line with the last thirty years of the company’s history: the idea of a bathroom that is flexible, comfortable and functional, where you can conduct everyday life simply and spontaneously:*

*The pictures in the catalogue are “real” locations. Lineabeta entered public and private spaces that differ in their style, taste and function, but are all connected to everyday life.*

*We took a peek into the privacy of different people, from the businessman who loves classic design, to the eccentric dj, the eclectic artist, the young couple with a baby; to the imaginative illustrator, discovering how each one lives the Lineabeta product in their own way; sometimes reinterpreting it, to ultimately come to the understanding that each person, in his/her own space, wants to feel good, to feel at home.*

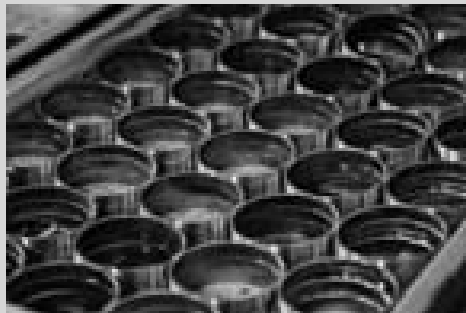

Una quotidianità che perdura da trent'anni. Trent'anni spesi a diventare uno dei primi 5 marchi in Italia nella produzione di accessori e complementi d'arredo per l'ambiente bagno. Trent'anni di tempo, energia, esperienza, innovazione, costanza, creatività, visione, legame col territorio, scelte in linea col mutare dei tempi, acuto spirito imprenditoriale glocal: tanti e tutti fattori necessari per durare e crescere.

Calzante interpretazione della gloCalizzazione di Bauman: i differenti materiali (vetro, ottone, acciaio, ceramica, bambù, mattstone) provengono da un contesto internazionale, vengono lavorati in Italia o all'estero a seconda della competitività delle manifatture e specializzazione delle lavorazioni, ma gli elementi strategici come l'immagine e la creatività del design sono rigorosamente made in Italy, come i nomi delle linee ispirati agli idiomi veneti (Picola, Noanta, Skuara, Venessia, Canavera, Ciacole, Bej, Ciuci...).

Nomi che si traducono in complementi belli e durevoli al giusto prezzo di mercato (globale); una politica premiata anno dopo anno che ha consentito all'azienda di conquistare mercati sempre nuovi.

*Everyday life for the last thirty years. Thirty years spent becoming one of the top 5 brands in Italy for the production of bathroom accessories and furnishings. Thirty years of time, energy, experience, innovation, perseverance, creativity, vision, a connection with the territory; choices that are in keeping with changing times, an acute glocal entrepreneurial spirit: many and all necessary factors to last and grow.*

*A very fitting interpretation of gloCalisation by Bauman: the different materials (glass, brass, steel, ceramic, bamboo, mattstone) come from an international context, processed in Italy or abroad depending on the competitiveness of the processing manufactures and specialisations, but the strategic elements such as the image and the creativity of the design are strictly 'made in Italy', as are the names of the lines inspired by Venetian expressions (Picola, Noanta, Skuara, Venessia, Canavera, Ciacole, Bej, Ciuci...).*

*Names that translate into beautiful and long-lasting accessories at a fair market price (global); a policy that has benefitted the company year after year allowing it to continue to conquer new markets.*

COLLEZIONI ACCESSORI / *ACCESSORIES COLLECTIONS*

BAKETO	accessori muro / <i>wall accessories</i>	12	PRICELIST	10
NOANTA	accessori muro / <i>wall accessories</i>	24	PRICELIST	18
SPRIZ	accessori muro / <i>wall accessories</i>	30	PRICELIST	23
PICOLA	accessori muro / <i>wall accessories</i>	34	PRICELIST	27
SKUARA	accessori muro / <i>wall accessories</i>	42	PRICELIST	32
VENESSIA	accessori muro / <i>wall accessories</i>	56	PRICELIST	39
NAPIE	accessori muro / <i>wall accessories</i>	66	PRICELIST	45
DUEMILA	accessori muro / <i>wall accessories</i>	76	PRICELIST	51
MUCI	accessori muro / <i>wall accessories</i>	86	PRICELIST	57

COLLEZIONI APPOGGIO / *TABLETOP ACCESSORIES*

SAON	accessori appoggio / <i>tabletop accessories</i>	96	PRICELIST	63
------	--	----	-----------	----

## HOTEL &amp; CONTRACT

OTEL	accessori hotellerie / <i>hotel accessories</i>	110	PRICELIST	71
------	---	-----	-----------	----

PIANTANE / *STANDS*

RANPIN	piantane / <i>floor stands</i>	122	PRICELIST	77
--------	--------------------------------	-----	-----------	----

SCOPINI / *BRUSH HOLDERS*

SKOATI	scopini / <i>toilet brush holders</i>	132	PRICELIST	83
--------	---------------------------------------	-----	-----------	----

LAVABI / *WASHBASINS*

MOMON	lavabi mattstone / <i>mattstone washbasins</i>	142	PRICELIST	89
ACQUAIO	vasche / <i>washbasins</i>	146	PRICELIST	92
QUARELO	lavabi ceramica / <i>ceramic washbasins</i>	152	PRICELIST	96
BOLE	mensole TOP in resina acrilica / <i>acrylic resin shelf TOP</i>	154	PRICELIST	97
ALBIO	vasche con supporto / <i>washbasins with wall bearing</i>	156	PRICELIST	98
GOTO	set supporto vasche / <i>wall bearing set</i>	158	PRICELIST	99
CIUCI	lavamani in mattstone con supporto / <i>mattstone handrinse basin</i>	160	PRICELIST	101
POCIA	vasche vetro / <i>glass washbasins</i>	162	PRICELIST	102
LISSIO	consolle lavabo / <i>frame with washbasin top</i>	164	PRICELIST	103

## RUBINETTERIA / TAPS & FITTINGS

BUSI & CANE	sifoni e pilette / <i>siphons and water drains</i>	170	PRICELIST 105
LINEA	rubinetti / <i>taps</i>	174	PRICELIST 109
CRUI	rubinetti / <i>taps</i>	186	PRICELIST 117
MUCI	rubinetti / <i>taps</i>	192	PRICELIST 120

## DOCCIA / SHOWER

FILO	portaoggetti doccia / <i>shower trays</i>	202	PRICELIST 125
SUPIONI	soffioni & Co. / <i>shower heads &amp; Co.</i>	206	PRICELIST 129
LINEA DOCCIA	supporti doccia / <i>rails &amp; Co.</i>	212	PRICELIST 134
ATLANTICA	pedane doccia / <i>shower wood mats</i>	218	PRICELIST 139

## CONTENITORI & MOBILI / CABINETS & FURNITURE

RUNNER	basi acciaio inox / <i>stainless steel units</i>	224	PRICELIST 143
PIKÀ	pensili con specchio / <i>mirrored cabinets</i>	228	PRICELIST 146
BEJ	contenitori legno / <i>plywood cabinets</i>	234	PRICELIST 150
CIACOLE	contenitori alluminio / <i>aluminum cabinets</i>	240	PRICELIST 153
CANAVERA	mobili bambù / <i>bamboo furniture collection</i>	250	PRICELIST 156

## SPECCHI & LAMPADE / MIRRORS & LAMPS

SPECI	specchi / <i>mirrors</i>	268	PRICELIST 165
MEVEDO	ingranditori / <i>magnifying mirrors</i>	280	PRICELIST 175
CIARI	lampade / <i>light fixtures</i>	286	PRICELIST 179

## COMPLEMENTI / FURNISHING

BASKET	cestini & Co. / <i>paper baskets &amp; Co.</i>	300	PRICELIST 185
SESTI	cesti biancheria / <i>laundry baskets</i>	304	PRICELIST 188
SEZIONI	cesti biancheria / <i>laundry baskets</i>	306	PRICELIST 189
BANDONI	cestini & Co. / <i>paper baskets &amp; Co.</i>	308	PRICELIST 190
SCAGNI	sedute / <i>stools</i>	310	PRICELIST 191
KORAME	accessori ecopelle / <i>ecoleather accessories</i>	312	PRICELIST 193
TAPEI	tappeti / <i>bath mats</i>	314	PRICELIST 194
GHEGHE	linea corpo / <i>body care line</i>	316	PRICELIST 195

FINITURE / FINISHING	318
----------------------	-----



52802-52803-52814-52844 SKUARA / 53697 ACQUAIO / 54234 CRUI / 5682 SPECI / 8061 CIACOLE /









diamante beghetto's home | artist | bassano del grappa | italy

---

COLLEZIONE ACCESSORI / *ACCESSORIES COLLECTIONS*

---

<b>BAKETO</b>	accessori muro / wall accessories		<b>12</b>	PRICELIST	10
<b>NOANTA</b>	accessori muro / wall accessories		<b>24</b>	PRICELIST	18
<b>SPRIZ</b>	accessori muro / wall accessories		<b>30</b>	PRICELIST	23
<b>PICOLA</b>	accessori muro / wall accessories		<b>34</b>	PRICELIST	27
<b>SKUARA</b>	accessori muro / wall accessories		<b>42</b>	PRICELIST	32
<b>VENESSIA</b>	accessori muro / wall accessories		<b>56</b>	PRICELIST	39
<b>NAPIE</b>	accessori muro / wall accessories		<b>66</b>	PRICELIST	45
<b>DUEMILA</b>	accessori muro / wall accessories		<b>76</b>	PRICELIST	51
<b>MUCI</b>	accessori muro / wall accessories		<b>86</b>	PRICELIST	57

---

# BAKETO

---

Essenzialità per gli spazi più piccoli: una serie innumerevole di accessori, dai portasapone alle mensole alle barre attrezzabili, in ottone cromato.

*Clean lines for tight spaces: a countless series of accessories, from soap holders to shelves to bars that can be equipped, in chrome-plated brass.*

---



55003



55006



55004



5200



52011



52012



5203



5204



5205



5214



52152



5216



5217

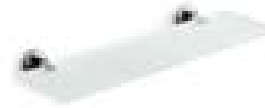

5234 +  
5276 - 5277 - 5278 - 5279



5222



5223

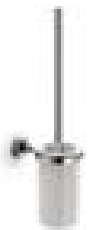

52061 + 55062



5208



52153



5209



5210 - 5211 - 5212



52241



5226



52261



52271



5229



52323



5233

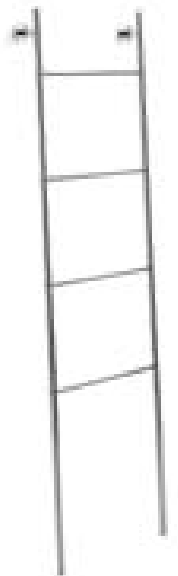

52352



**55003** Bicchiere /  
*Tumbler*  
Ø 75 x H 105 mm

**55006** Spandisapone 200 ml /  
*Soap dispenser 200 ml*  
Ø 75 x H 175 mm

**55004** Portasapone /  
*Soap dish*  
Ø 120 x H 30 mm



**5200** Griglietta in silicone antiscivolo per  
Art. 55004 (20 pezzi assortiti in 4 colori) /  
*Silicon grid for Art. 55004*  
(20 pieces, 4 colours)  
Ø 50 x H 18 mm



**52011** Supporto singolo /  
*Single holder*  
Ø 70 x H 40 x P 120 mm



**52012** Supporto doppio /  
*Double holder*  
L 200 x H 40 x P 105 mm



---

**5203** Portarotolo coperto /  
*Toilet paper holder with lid*  
L 135 x H 80 x P 125 mm

---



---

**5204** Portarotolo /  
*Toilet paper holder*  
L 155 x H 40 x P 100 mm

---



---

**5205** Portarotolo doppio /  
*Double toilet paper holder*  
L 265 x H 40 x P 100 mm

---





---

**55062** Porta scopino /  
*Toilet brush*  
Ø 90 x H 395 mm

---

---

**52061** Supporto porta scopino /  
*Toilet brush holder*  
L 90 x H 40 x P 130 mm

---



---

**5208** Coppia appendiabiti /  
*2 hooks*  
Ø 40 x P 55 mm

---





---

**52153** Anello porta salvietta /  
*Towel ring*  
Ø 50 x H 40 x P 95 mm

---



---

**5209** Anello porta salvietta /  
*Towel ring*  
L 200 x H 210 x P 90 mm

---



---

Porta salvietta /  
*Towel rail*

**5210** L 400 x H 40 x P 90 mm

**5211** L 500 x H 40 x P 90 mm

**5212** L 600 x H 40 x P 90 mm

---

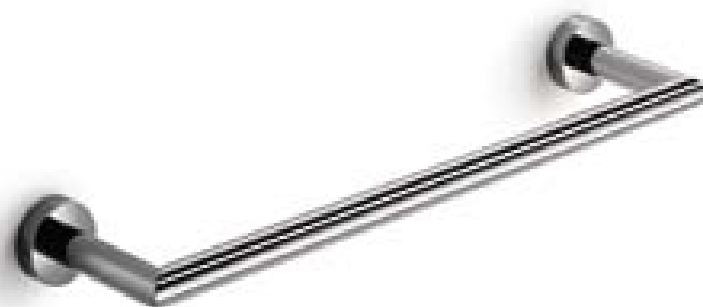

---

**52152** Porta salvietta doppio snodato /  
*Double jointed towel rail*

L 380 x H 150 x P 65 mm

---



---

**5214** Porta salvietta doppio /  
*Double towel rail*  
L 600 x H 40 x P 160 mm

---

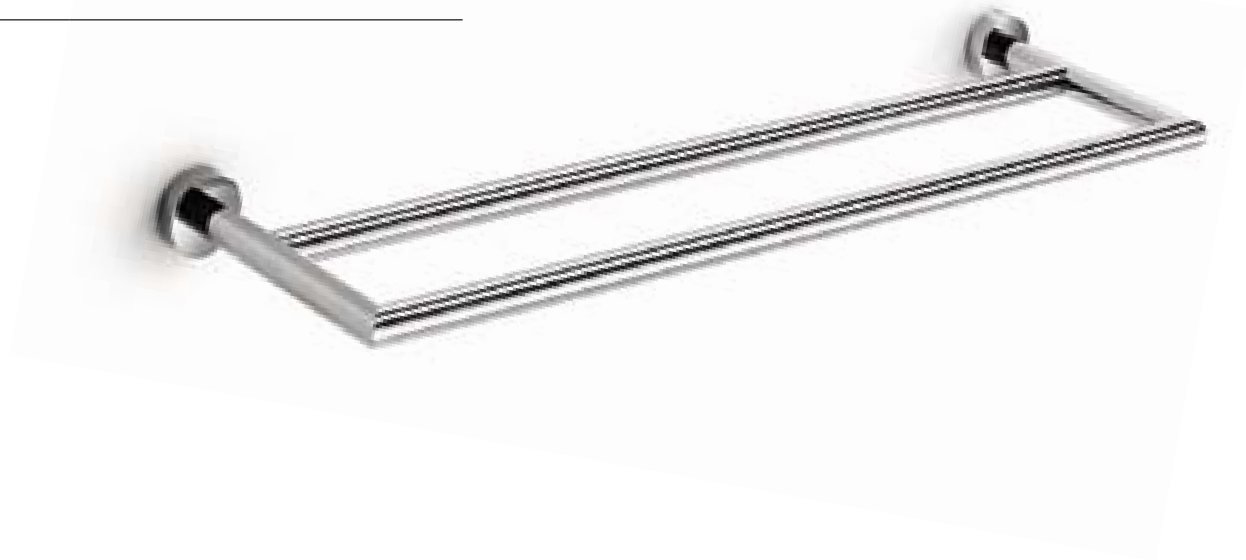

---

**5216** Griglia porta salviette /  
*Towel shelf*  
L 600 x H 40 x P 260 mm

---



---

**5217** Spandisapone a parete 180 ml /  
*Wall soap dispenser 180 ml*  
Ø 50 x H 165 x P 90 mm

---



---

**5234** Coppia supporti mensola /  
*Shelf wall bearing (1 pair)*  
Ø 40 x P 50 mm

---

Mensola vetro /  
*Glass shelf*

**5276.81** L 392 x H 8 x P 115 mm

**5277.81** L 492 x H 8 x P 115 mm

**5278.81** L 592 x H 8 x P 115 mm

**5279.81** L 792 x H 8 x P 115 mm

---

---

**5222** Barra attrezzabile /  
*Rail for accessories*  
L 40 x H 420 x P 90 mm

---



---

Barra attrezzata /  
*Accessoried rail*

---

**5222** Barra attrezzabile /  
*Rail for accessories*

---

**5226** Portarotolo per barra /  
*Toilet paper holder for rail*

---

**52271** Supporto scopino per barra /  
*Toilet brush holder for rail*

---

**55062.09** Porta scopino /  
*Toilet brush*

---



---

**5223** Barra attrezzabile /  
*Rail for accessories*  
L 40 x H 820 x P 90 mm

---



---

Barra attrezzata /  
*Accessoried rail*

---

**5223** Barra attrezzabile /  
*Rail for accessories*

---

**52261** Appendino doppio per barra /  
*Double hook for rail*

---

**52323** Specchio ingranditore per barra /  
*Magnifying mirror for rail*

---

**52241** Supporto per barra /  
*Single holder for rail*

---

**55003.81** Bicchiere /  
*Tumbler*

---

**5229** Porta salvietta per barra /  
*Towel rail for rail*

---

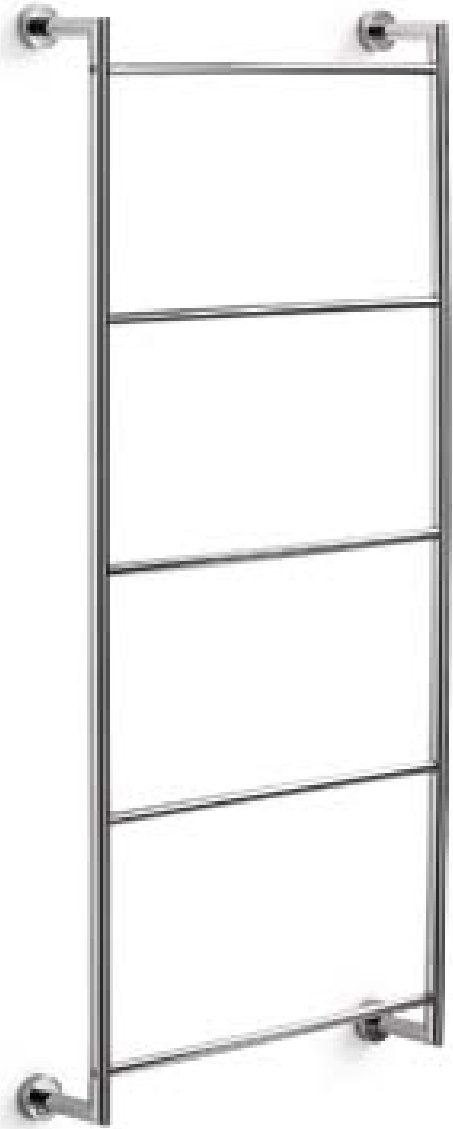
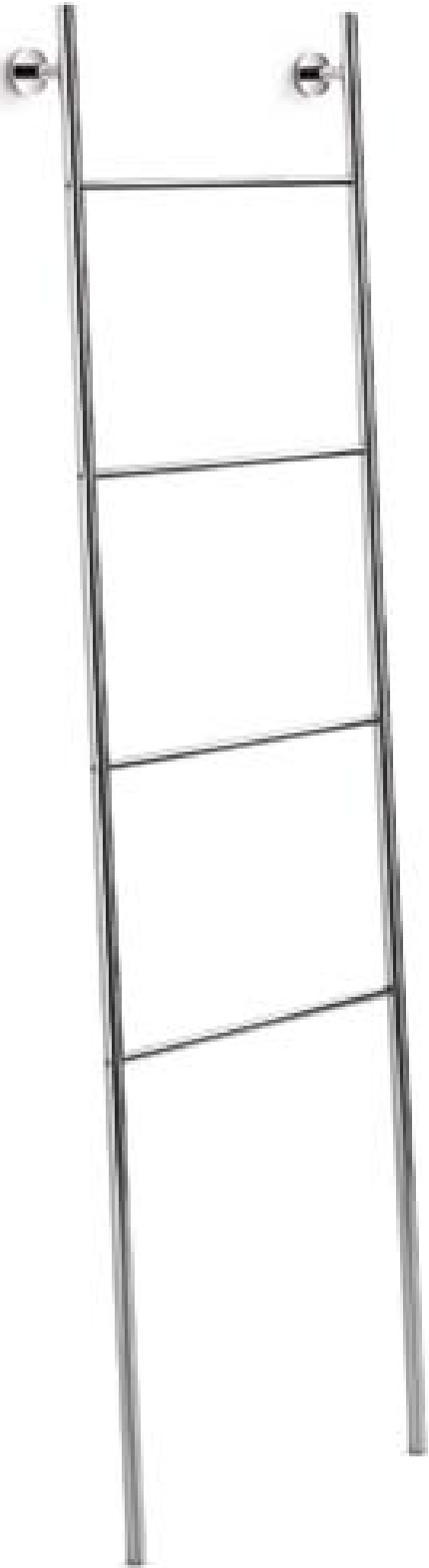

---

**52352** Scaletta porta salviette /  
*Towel rack*  
L 480 x H 1600 x P 180 mm

---

---

**5233** Griglia porta salviette /  
*Towel rail*  
L 465 x H 990 x P 90 mm

---

---

# NOANTA

---

Così sottile e semplice è la sua forma: non è nient'altro che il vuoto da essa delimitato. Serie in ottone cromato.

*So subtle and simple is its form: it is not nothing but empty space bounded by it. Chromed brass series.*

---

GLUE



55003



55006



55004



5200



52371



52372

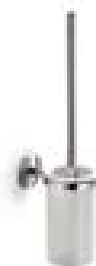

52374 + 55062



52375



52377 - 52378



52379



52380



52381



52384  
5276 - 5277 - 5278 - 5279



52387



52388

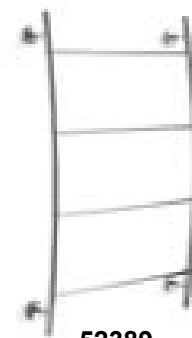

52389





**55003** Bicchiere /  
*Tumbler*  
Ø 75 x H 105 mm

**55006** Spandisapone 200 ml /  
*Soap dispenser 200 ml*  
Ø 75 x H 175 mm

**55004** Portasapone /  
*Soap dish*  
Ø 120 x H 30 mm



**5200** Griglietta in silicone antiscivolo per  
Art. 55004 (20 pezzi assortiti in 4 colori) /  
*Silicon grid for Art. 55004*  
*(20 pieces, 4 colours)*  
Ø 50 x H 18 mm



---

**52371** Supporto singolo /  
*Single holder*

Ø 70 x H 55 x P 115 mm

---



---

**52372** Supporto doppio /  
*Double holder*

L 200 x H 55 x P 105 mm

---



---

**55062** Porta scopino /  
*Toilet brush*

Ø 90 x H 395 mm

---

---

**52374** Supporto porta scopino a parete /  
*Toilet brush holder*

Ø 90 x H 55 x P 125 mm

---



---

**52375** Portarotolo coperto /  
*Toilet paper holder with lid*  
L 165 x H 120 x P 160 mm

---



---

Porta salvietta /  
*Towel rail*

**52377** L 440 x H 55 x P 80 mm  
**52378** L 640 x H 55 x P 90 mm

---



---

**52379** Porta salvietta doppio /  
*Double towel rail*  
L 640 x H 55 x P 155 mm

---



---

**52380** Griglia con porta salviette /  
*Shelf with towel rack*  
L 655 x H 125 x P 235 mm

---



---

**52381** Anello porta salvietta /  
*Towel ring*  
L 240 x H 230 x P 60 mm

---



---

**52384** Coppia supporti mensola /  
*Shelf wall bearing (1 pair)*  
Ø 55 x P 70 mm

---

Mensola vetro /  
*Glass shelf*

**5276.81** L 392 x H 8 x P 115 mm

**5277.81** L 492 x H 8 x P 115 mm

**5278.81** L 592 x H 8 x P 115 mm

**5279.81** L 792 x H 8 x P 115 mm

---



---

**52387** Appendiabiti doppio /  
*Double hook*  
L 95 x H 55 x P 45 mm

---



---

**52388** Appendiabiti /  
*Hook*  
L 55 x H 145 x P 90 mm

---



---

**52389** Griglia porta salviette /  
*Towel shelf*  
L 640 x H 920 x P 110 mm

---

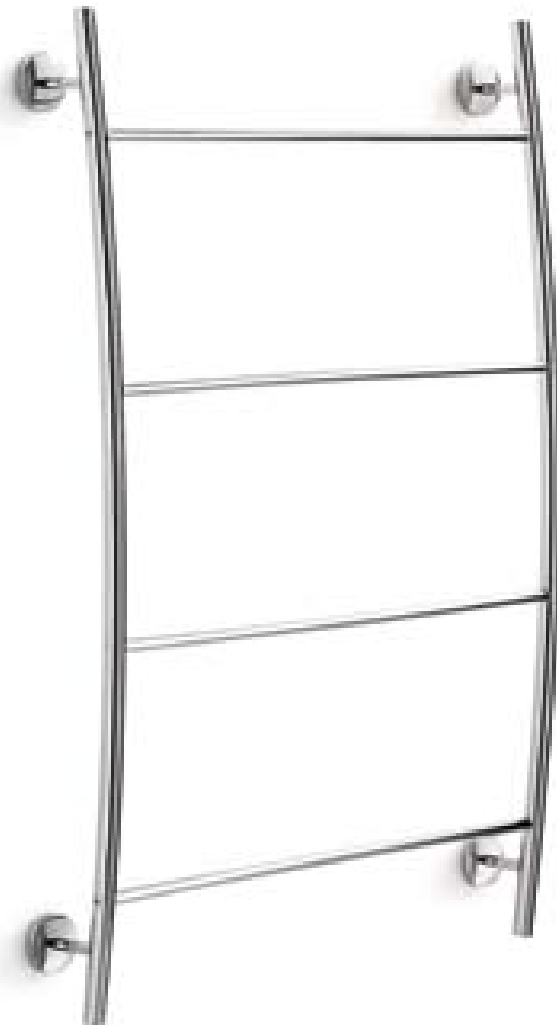

---

# SPRIZ

---

Essenziale ed attuale questa collezione di accessori studiata per la collettività, griglie, porta rotoli, porta salviette in ottone cromato.

*Essential and up-to-date, this collection of accessories is designed for public facilities, chrome-plated brass racks, toilet paper dispensers, towel bars.*

---

GLUE



55003



55006



55004



5200



52401



52408



52409



52414 - 52416



52417



52426



52432



5526 +  
5276 - 5277 - 5278 - 5279



**55003** Bicchiere /  
*Tumbler*  
Ø 75 x H 105 mm

**55006** Spandisapone 200 ml /  
*Soap dispenser 200 ml*  
Ø 75 x H 175 mm

**55004** Portasapone /  
*Soap dish*  
Ø 120 x H 30 mm



**5200** Griglietta in silicone antiscivolo per  
Art. 55004 (20 pezzi assortiti in 4 colori) /  
*Silicon grid for Art. 55004*  
*(20 pieces, 4 colours)*  
Ø 50 x H 18 mm



---

**52401** Supporto singolo /  
*Single holder*  
Ø 70 x H 50 x P 110 mm

---



---

**52408** Portarotolo /  
*Toilet paper holder*  
L 180 x H 50 x P 95 mm

---



---

**52409** Portarotolo doppio /  
*Double toilet paper holder*  
L 315 x H 50 x P 100 mm

---



---

Porta salvietta /  
*Towel rail*

**52414** L 480 x H 50 x P 75 mm

**52416** L 650 x H 50 x P 75 mm

---

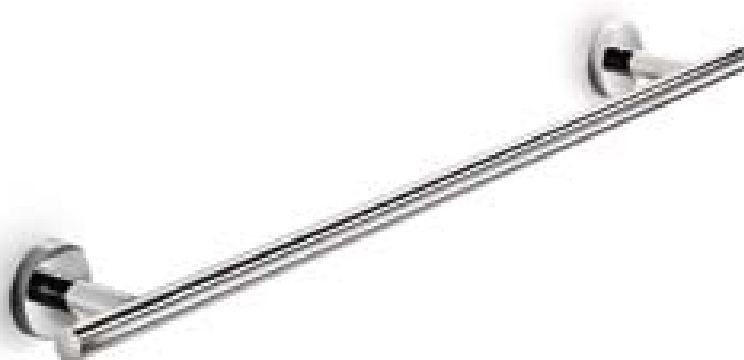



**52417** Porta salvietta doppio /  
*Double towel rail*  
L 650 x H 50 x P 147 mm

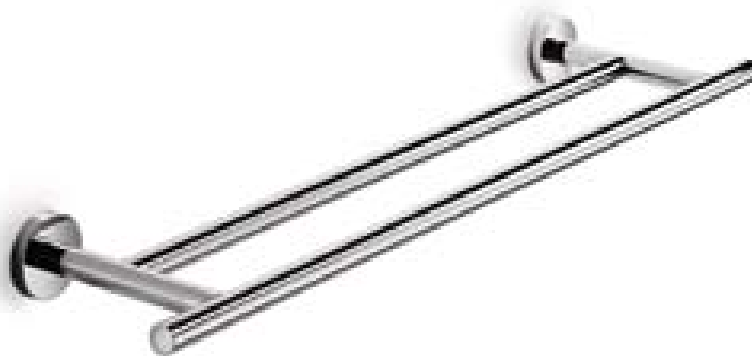

**52426** Griglia porta salviette /  
*Towel shelf*  
L 620 x H 140 x P 235 mm



**52432** Coppia appendiabiti /  
*2 hooks*  
Ø 50 x P 65 mm



**5526** Coppia supporti mensola /  
*Shelf wall bearing (1 pair)*  
Ø 50 x P 40 mm

Mensola vetro /  
*Glass shelf*

**5276.81** L 392 x H 8 x P 115 mm

**5277.81** L 492 x H 8 x P 115 mm

**5278.81** L 592 x H 8 x P 115 mm

**5279.81** L 792 x H 8 x P 115 mm



---

# PICOLA

---

Linea di accessori in ottone cromato, dei veri e propri passe-partout, non subordinati agli stili e alle tendenze del momento.

*A line of chrome-plated brass accessories, authentic passe-partouts, that are not affected by passing styles and trends.*

---



55003



55006



55004



5200



52511



52510



5253



52535



5257



5254



5255



52561 + 55062

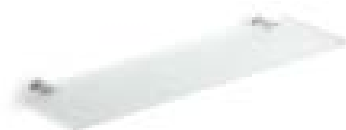

5273 +  
5276 - 5277 - 5278 - 5279



5258



5259



5260 - 5262 - 5263



5264

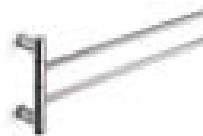

5265



5266



**55003** Bicchiere /  
*Tumbler*  
Ø 75 x H 105 mm

**55006** Spandisapone 200 ml /  
*Soap dispenser 200 ml*  
Ø 75 x H 175 mm

**55004** Portasapone /  
*Soap dish*  
Ø 120 x H 30 mm



**5200** Griglietta in silicone antiscivolo per  
Art. 55004 (20 pezzi assortiti in 4 colori) /  
*Silicon grid for Art. 55004*  
*(20 pieces, 4 colours)*  
Ø 50 x H 18 mm



**52511** Supporto singolo /  
*Single holder*  
Ø 70 x Ø 20 x P 135 mm



**52510** Borchia per serie 'PICOLA' /  
*Stud for 'PICOLA' range*  
Ø 40 x H 2 mm



---

**5253** Portarotolo coperto /  
*Toilet paper holder with lid*  
L 120 x H 75 x P 150 mm

---



---

**52535** Portarotolo /  
*Toilet paper holder*  
L 136 x H 60 x P 90 mm

---



---

**5257** Portarotolo coperto /  
*Toilet paper holder with lid*  
L 135 x H 75 x P 125 mm

---



---

**5254**

Portarotolo /  
*Toilet paper holder*

Ø 20 x H 35 x P 125 mm

---



---

**5255**

Riserva rotoli /  
*Toilet paper holder*

Ø 20 x H 400 x P 90 mm

---

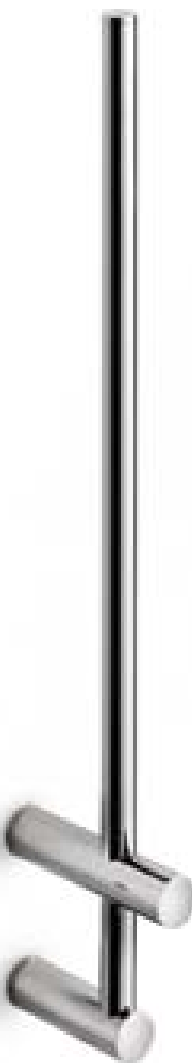



**55062** Porta scopino /  
*Toilet brush*  
Ø 90 x H 395 mm

**52561** Supporto scopino /  
*Toilet brush holder*  
Ø 90 x Ø 20 x P 130 mm



**5273** Coppia supporti mensola /  
*Shelf wall bearing (1 pair)*  
Ø 20 x P 30 mm

Mensola vetro /  
*Glass shelf*

**5276.81** L 392 x H 8 x P 115 mm

**5277.81** L 492 x H 8 x P 115 mm

**5278.81** L 592 x H 8 x P 115 mm

**5279.81** L 792 x H 8 x P 115 mm



---

**5258** Coppia appendiabiti /  
*2 hooks*  
Ø 20 x H 35 x P 50 mm

---



---

**5259** Anello porta salvietta /  
*Towel ring*  
Ø 180 x H 185 x P 50 mm

---



---

Porta salvietta /  
*Towel rail*

**5260** L 400 x Ø 20 x P 80 mm

**5262** L 600 x Ø 20 x P 80 mm

**5263** L 700 x Ø 20 x P 80 mm

---

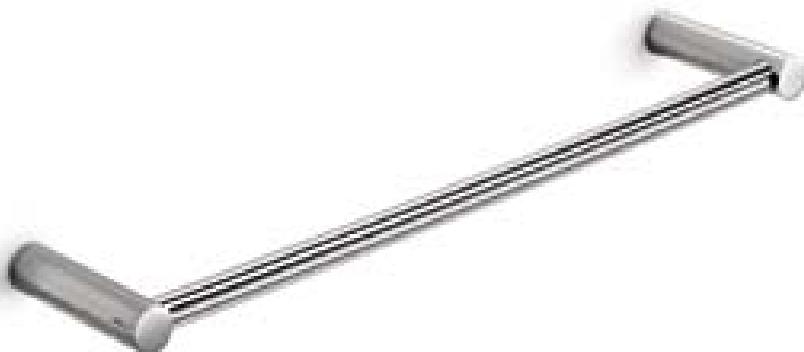



---

**5264** Porta salvietta doppio /  
*Double towel rail*  
L 600 x Ø 20 x P 125 mm

---

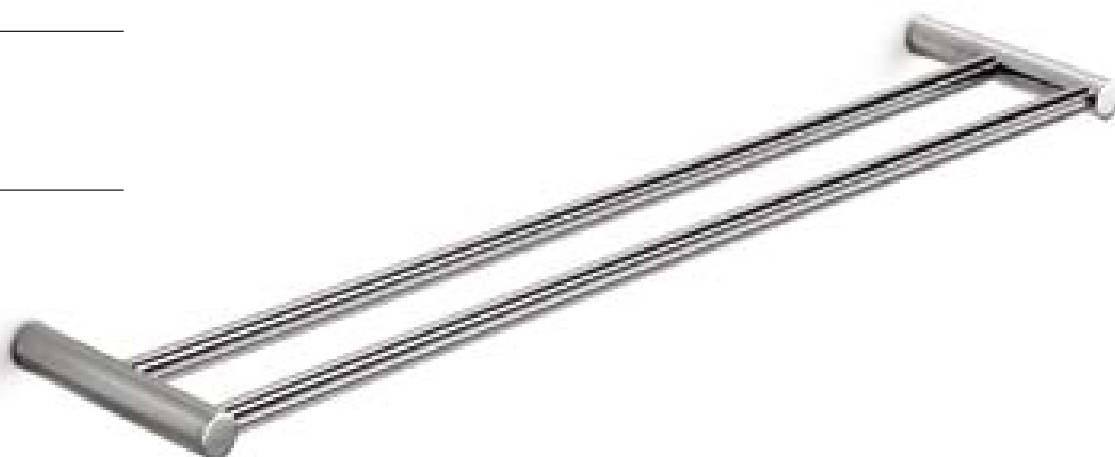

---

**5265** Porta salvietta snodato /  
*Jointed towel rail*  
L 370 x H 140 x P 54 mm

---

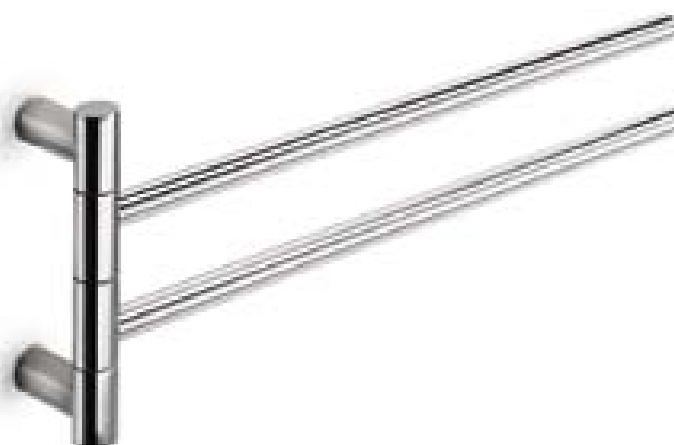

---

**5266** Griglia porta salviette /  
*Towel shelf*  
L 600 x H 50 x P 235 mm

---



---

# SKUARA

---

Una completa linea di complementi per definire l'arredamento del bagno con soluzioni agili e personalizzabili. Dettagli curati, e linee squadrate per una serie in ottone cromato, acciaio e ceramica.

*A complete line of accessories to define bathroom furnishings with agile and customisable solutions. Attention to detail, and square lines for this series in chrome-plated brass, steel and ceramic.*

---



52801.09



52802.09



52803.09



52801.29



52802.29



52803.29



52810 - 52811  
52812 - 52813



52814 - 52815  
52816 - 52818



52826



52834 - 52836

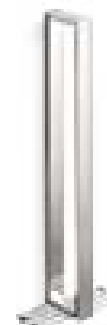

52819



52804.09

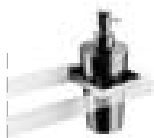

52804.29



52806



52807



52805.09

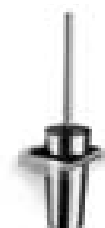

52805.29



52853



52867



52843 - 52846



52844 - 52848



52866



52868

---

**52801.09** Bicchiere, supporto minimo 80 mm /  
*Tumbler, bracket minimum size 80 mm*

L 82 x H 110 x P 100 mm

---



---

**52802.09** Portasapone, supporto minimo 120 mm /  
*Soap dish, bracket minimum size 120 mm*

L 120 x H 45 x P 100 mm

---



---

**52803.09** Porta spugna, supporto minimo 200 mm /  
*Sponge dish, bracket minimum size 200 mm*

L 204 x H 45 x P 100 mm

---



**52801.29** Bicchiere, supporto minimo 80 mm /  
*Tumbler, bracket minimum size 80 mm*  
 L 74 x H 100 x P 97 mm



**52802.29** Porta sapone, supporto minimo 120 mm /  
*Soap dish, bracket minimum size 120 mm*  
 L 113 x H 15 x P 92 mm



**52803.29** Porta spugna, supporto minimo 200 mm /  
*Sponge dish, bracket minimum size 200 mm*  
 L 197 x H 15 x P 97 mm



---

**52804.09** Spandisapone 300 ml, supporto minimo 80 mm /  
*Soap dispenser 300 ml, bracket minimum size 80 mm*  
L 80 x H 151 x P 100 mm

---



---

**52804.29** Spandisapone 350 ml, supporto minimo 80 mm /  
*Soap dispenser 350 ml, bracket minimum size 80 mm*  
L 74 x H 175 x P 97 mm

---



---

**52806** Portarotolo /  
*Toilet paper holder*  
L 130 x H 25 x P 135 mm

---



---

**52807** Portarotolo doppio /  
*Double toilet paper holder*  
L 250 x H 25 x P 135 mm

---



---

**52805.29** Porta scopino, supporto minimo 100 mm /  
*Toilet brush holder, bracket minimum size 100 mm*  
L 97 x H 410 x P 93 mm

---



---

**52805.09** Porta scopino, supporto minimo 100 mm /  
*Toilet brush holder, bracket minimum size 100 mm*  
L 100 x H 395 x P 100 mm

---





---

 Supporto /  
*Bracket*

<b>52808</b>	L 82 x H 25 x P 100 mm
<b>52810</b>	L 100 x H 25 x P 100 mm
<b>52811</b>	L 120 x H 25 x P 100 mm
<b>52812</b>	L 200 x H 25 x P 100 mm
<b>52813</b>	L 300 x H 25 x P 100 mm

---





---

 Supporto e porta salvietta /  
*Bracket and towel rail*

<b>52814</b>	L 400 x H 25 x P 100 mm
<b>52815</b>	L 500 x H 25 x P 100 mm
<b>52816</b>	L 600 x H 25 x P 100 mm
<b>52818</b>	L 800 x H 25 x P 100 mm

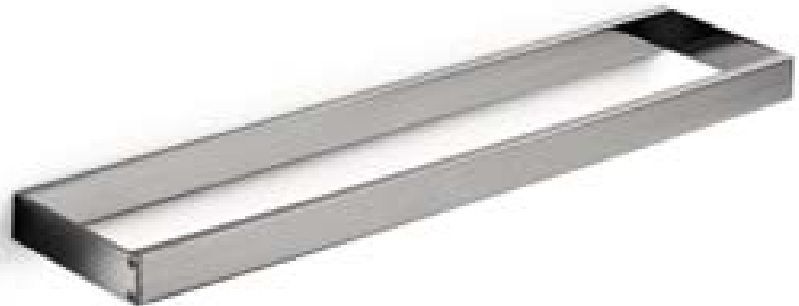
---



---

<b>52826</b>	Porta salvietta doppio / <i>Double towel rail</i>
	L 600 x H 25 x P 150 mm

---



---

Mensola /  
*Shelf*

**52834** L 400 x H 25 x P 135 mm

**52836** L 600 x H 25 x P 135 mm

---



---

**52819** Porta salviette verticale /  
*Vertical towel holder*

L 150 x H 400 x P 70 mm

---





---

Barra attrezzata /  
*Accessoried rail*

---

**52816** Supporto e porta salvietta /  
*Accessories holder and towel rail*

---

**52804.29** Spandisapone /  
*Soap dispenser*

---

**52803.29** Porta spugna /  
*Sponge dish*

---



---

Barra attrezzata /  
*Accessoried rail*

---

**52818** Supporto e porta salvietta /  
*Accessories holder and towel rail*

---

**52804.09** Spandisapone /  
*Soap dispenser*

---

**52802.09** Portasapone /  
*Soap dish*

---

**52801.09** Bicchiere /  
*Tumbler*

---

---

**52853** Appendiabiti doppio /  
*Double hook*  
L 155 x H 40 x P 50 mm

---



---

**52867** Griglia con porta salviette /  
*Shelf with towel rail*  
L 600 x H 115 x P 250 mm

---



---

Griglia /  
*Shelf*

**52843** L 300 x H 25 x P 135 mm

**52845** L 500 x H 25 x P 135 mm

---



---

Griglia /  
*Shelf*

**52844** L 400 x H 25 x P 135 mm

**52846** L 600 x H 25 x P 135 mm

---



---

**52866** Griglia /  
*Shelf*

L 600 x H 25 x P 250 mm

---



---

**52868** Scaletta porta salviette /  
*Towel rack*  
L 480 x H 1600 x P 192 mm

---



---

# VENESSIA

---

design **Roy Frame**

Linee eleganti, rigorose, e richiami a un grande passato in ottone cromato: anche la rigidità può accompagnarsi a forme dal sapore antico e ricercato.

*Elegant, precise lines and features from a great past of chrome-plated brass: even precision can be combined with shapes in an old and sophisticated style.*

---

GLUE



52901



52903



52902



52906



52938



52939

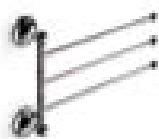

52920



52925



52926



52921





52907



52908



52909



52914 - 52916

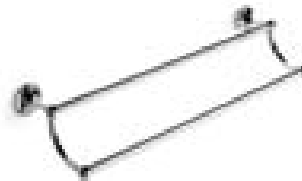

52917



52918



52932 +  
5276 - 5277 - 5278 - 5279

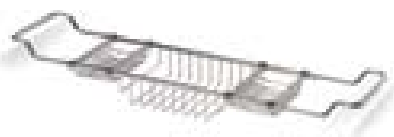

52924



52942

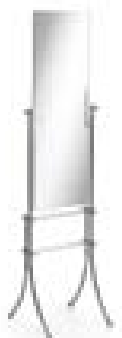

52944

---

**52901** Porta bicchiere con bicchiere /  
*Holder with tumbler*  
Ø 83 x H 145 x P 150 mm

---



---

**52903** Porta bicchiere con doppio bicchiere /  
*Double holder with tumblers*  
L 206 x H 145 x P 115 mm

---



---

**52902** Portasapone con piattino /  
*Holder with soap dish*  
L 150 x H 75 x P 130 mm

---



---

**52906** Porta scopino con vaso /  
*Toilet brush with holder*  
Ø 90 x H 385 x P 165 mm

---



---

**52938** Appendiabiti /  
*Hook*  
Ø 57 x H 138 x P 100 mm

---



---

**52939** Appendiabiti doppio /  
*Double hook*  
L 120 x H 95 x P 65 mm

---



---

**52907** Portarotolo coperto /  
*Toilet paper holder with lid*  
L 160 x H 160 x P 90 mm

---



---

**52908** Portarotolo /  
*Toilet paper holder*  
L 160 x H 120 x P 65 mm

---



---

**52909** Portarotolo doppio /  
*Double toilet paper holder*  
L 295 x Ø 57 x P 85 mm

---

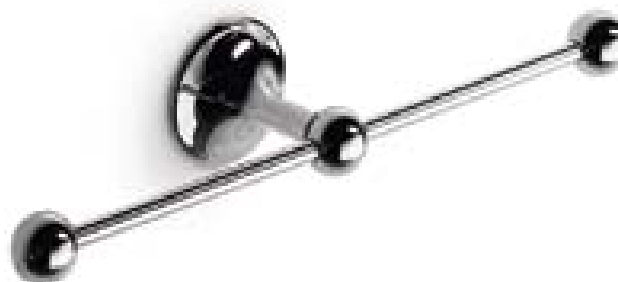

---

Porta salvietta /  
*Towel rail*

**52914** L 457 x H 57 x P 85 mm

**52916** L 657 x H 57 x P 85 mm

---



---

**52917** Porta salvietta doppio /  
*Double towel rail*

L 657 x H 120 x P 165 mm

---



---

**52918** Porta salvietta doppio /  
*Double towel rail*

L 177 x H 57 x P 400 mm

---



---

**52920** Porta salvietta snodato /  
*Jointed towel rail*  
L 340 x H 235 x P 65 mm

---

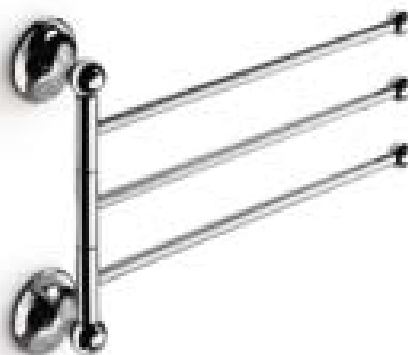

---

**52925** Griglia porta salviette doppia /  
*Double towel shelf*  
L 760 x H 217 x P 230 mm

---



---

**52926** Griglia con porta salvietta /  
*Shelf with towel rack*  
L 657 x H 140 x P 220 mm

---



---

**52921** Anello porta salvietta /  
*Towel ring*  
L 200 x H 222 x P 85 mm

---



---

**52932** Coppia supporti mensola /  
*Shelf wall bearing (1 pair)*  
Ø 57 x P 30 mm

---

Mensola vetro /  
*Glass shelf*

**5276.81** L 392 x H 8 x P 115 mm

**5277.81** L 492 x H 8 x P 115 mm

**5278.81** L 592 x H 8 x P 115 mm

**5279.81** L 792 x H 8 x P 115 mm

---



---

**52924** Traversa vasca /  
*Bath tub bridge*  
L min 600 - max 900 x H 97 x P 210 mm

---

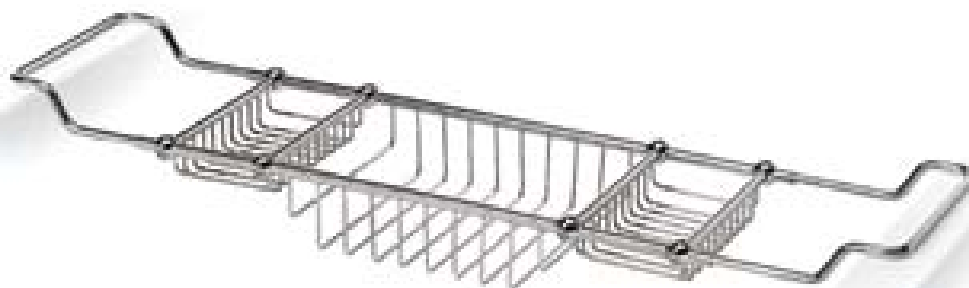



---

**52942** Piantana porta salvietta /  
*Towel rack*  
L 675 x H 895 x P 350 mm

---



---

**52944** Piantana specchio /  
*Mirror rack*  
L 430 x H 1650 x P 425 mm

---



---

# NAPIE

---

Collezione di accessori dalla solidità massiccia. Supporti, porta salviette e tanto altro, tutto in ottone cromato.

*A collection of accessories featuring robust solidity. Supports, towel racks and much more, all in chrome-plated brass.*

---



53020



53022



53021



53011



53012



53013

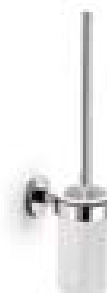

53066 + 55062



53119



53131



53111



53112



53114 - 53116



53118



53064



53061

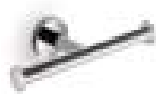

53063



53065



53081



53082



53132

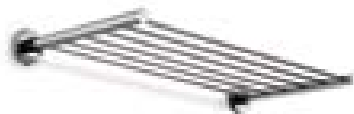

53141

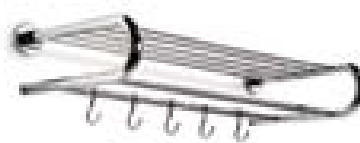

53151



53153 +  
5276 - 5277 - 5278 - 5279



**53020** Bicchiere /  
*Tumbler*  
Ø 80 x H 105 mm

**53022** Spandisapone, 300 ml /  
*Soap dispenser, 300 ml*  
Ø 80 x H 155 mm

**53021** Portasapone /  
*Soap dish*  
Ø 120 x H 45 mm

**53011** Supporto singolo /  
*Single holder*  
Ø 70 x H 60 x P 115 mm



---

**53012** Supporto doppio /  
*Double holder*  
L 215 x H 60 x P 100 mm

---



---

**53013** Supporto con porta salvietta /  
*Holder with towel rail*  
L 320 x H 60 x P 100 mm

---





---

**55062** Porta scopino /  
*Toilet brush*  
Ø 90 x H 395

---

---

**53066** Supporto porta scopino /  
*Toilet brush holder*  
Ø 90 x H 60 x P 125 mm

---



---

**53064** Portarotolo coperto /  
*Toilet paper holder with lid*  
L 135 x H 160 x P 80 mm

---



---

**53061** Portarotolo /  
*Toilet paper holder*  
L 165 x H 60 x P 110 mm

---



---

**53063** Portarotolo doppio /  
*Double toilet paper holder*  
L 250 x H 60 x P 110 mm

---



---

**53065** Riserva rotoli /  
*Toilet paper holder*  
L 60 x H 260 x P 100 mm

---



---

**53081** Coppia appendi abiti singoli /  
*2 hooks*

Ø 60 x P 50 mm

---



---

**53082** Appendi abiti doppio /  
*Double hook*

L 140 x H 60 x P 40 mm

---



---

**53119** Anello porta salvietta /  
*Towel ring*

Ø 60 x P 95 mm

---





---

**53131** Anello porta salvietta /  
*Towel ring*  
L 220 x H 155 x P 60 mm

---



---

**53111** Porta salvietta /  
*Towel rail*  
Ø 60 x P 360 mm

---



---

**53112** Porta salvietta doppio /  
*Double towel rail*  
L 500 x H 60 x P 90 mm

---



---

Porta salvietta /  
*Towel rail*

**53114** L 400 x H 60 x P 90 mm

**53116** L 600 x H 60 x P 90 mm

---



---

**53118** Porta salvietta doppio /  
*Double towel rail*

L 600 x H 60 x P 155 mm

---

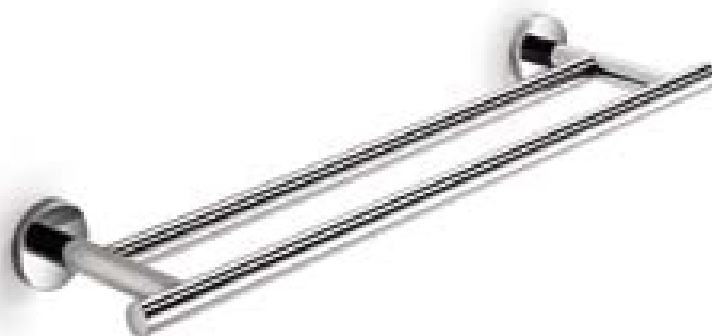

---

**53132** Porta salvietta snodato /  
*Jointed towel rail*

L 390 x H 170 x P 52 mm

---

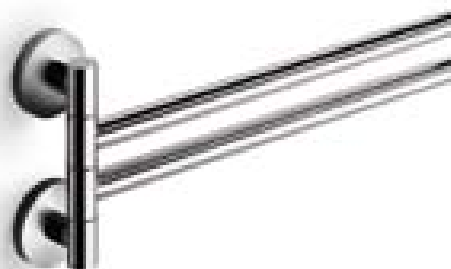

**53141** Griglia porta salvietta /  
*Towel shelf*  
L 600 x H 60 x P 300 mm



**53151** Griglia con porta salvietta /  
*Shelf with towel rack*  
L 700 x H 140 x P 310 mm



**53153** Coppia supporti mensola /  
*Shelf wall bearing (1 pair)*  
Ø 60 x P 45 mm

Mensola vetro /  
*Glass shelf*

**5276.81** L 392 x H 8 x P 115 mm

**5277.81** L 492 x H 8 x P 115 mm

**5278.81** L 592 x H 8 x P 115 mm

**5279.81** L 792 x H 8 x P 115 mm



---

# DUEMILA

---

Linee pulite e leggere per questa collezione di accessori essenziale e pratica che comprende supporti, griglie, portarotoli, porta salviette in ottone cromato.

*Clean and light lines distinguish this collection of basic and practical accessories which includes chrome-plated brass supports, racks, toilet paper dispensers, towel bars.*

---

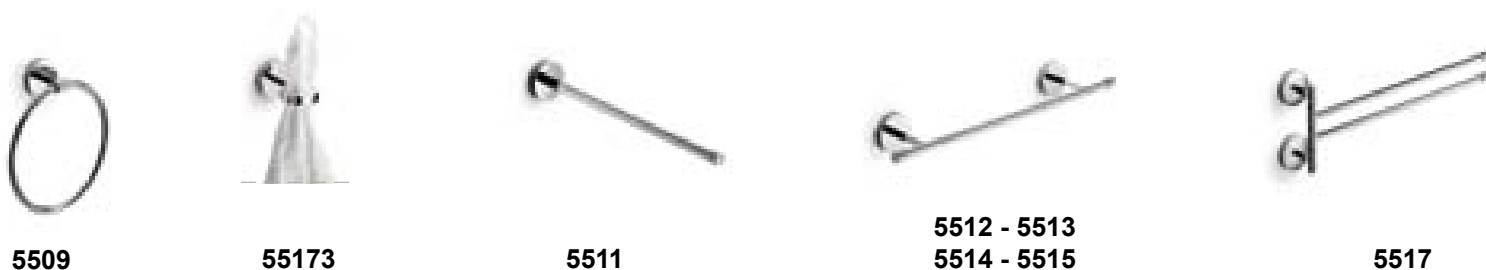

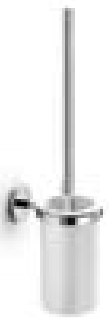

55061 + 55062



5507



5504



5505



5508



5510



5519

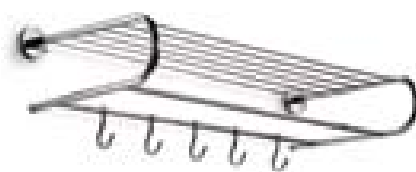

5522



5526 +  
5276 - 5277 - 5278 - 5279



**55003** Bicchiere /  
*Tumbler*  
Ø 75 x H 105 mm

**55006** Spandisapone, 200 ml /  
*Soap dispenser; 200 ml*  
Ø 75 x H 175 mm

**55004** Portasapone /  
*Soap dish*  
Ø 120 x H 30 mm



**5200** Griglietta in silicone antiscivolo per  
Art. 55004 (20 pezzi assortiti in 4 colori) /  
*Silicon grid for Art. 55004*  
(20 pieces, 4 colours)  
Ø 50 x H 18 mm



**55001** Supporto singolo /  
*Single holder*  
Ø 70 x H 50 x P 115 mm



**55002** Supporto doppio /  
*Double holder*  
L 200 x H 50 x P 100 mm



---

**5503** Spandisapone, 180 ml /  
*Soap dispenser, 180 ml*  
Ø 50 x H 164 x P 90 mm

---



---

**55032** Spandisapone, 220 ml /  
*Soap dispenser, 220 ml*  
Ø 50 x H 200 x P 90 mm

---





---

**55062** Porta scopino /  
*Toilet brush*  
Ø 90 x H 395 mm

---

---

**55061** Supporto porta scopino a parete /  
*Toilet brush holder*  
Ø 90 x H 50 x P 125 mm

---



---

**5507** Coppia appendiabiti /  
*2 hooks*  
Ø 50 x P 45 mm

---





**5504** Portarotolo /  
*Toilet paper holder*  
L 160 x H 50 x P 90 mm



**5505** Portarotolo doppio /  
*Double toilet paper holder*  
L 245 x H 50 x P 90 mm



**5508** Portarotolo /  
*Toilet paper holder*  
Ø 50 x P 135 mm



**5510** Portarotolo coperto /  
*Toilet paper holder with lid*  
L 135 x H 80 x P 125 mm



---

**5509** Anello porta salvietta /  
*Towel ring*  
Ø 180 x H 200 x P 55 mm

---



---

**55173** Anello porta salvietta /  
*Towel ring*  
Ø 50 x P 95 mm

---



---

**5511** Porta salvietta /  
*Towel rail*  
Ø 50 x P 310 mm

---





---

Porta salvietta /  
*Towel rail*

**5512** L 400 x H 50 x P 85 mm  
**5513** L 500 x H 50 x P 85 mm  
**5514** L 600 x H 50 x P 85 mm  
**5515** L 700 x H 50 x P 85 mm

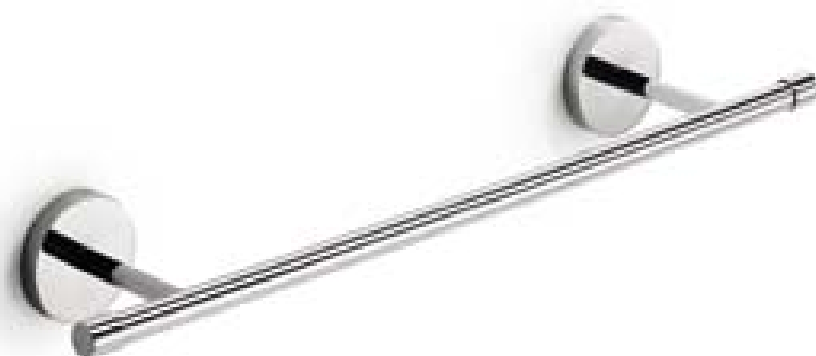
---





---

**5517** Porta salvietta doppio snodato /  
*Double jointed towel rail*  
L 390 x H 145 x 50 mm

---

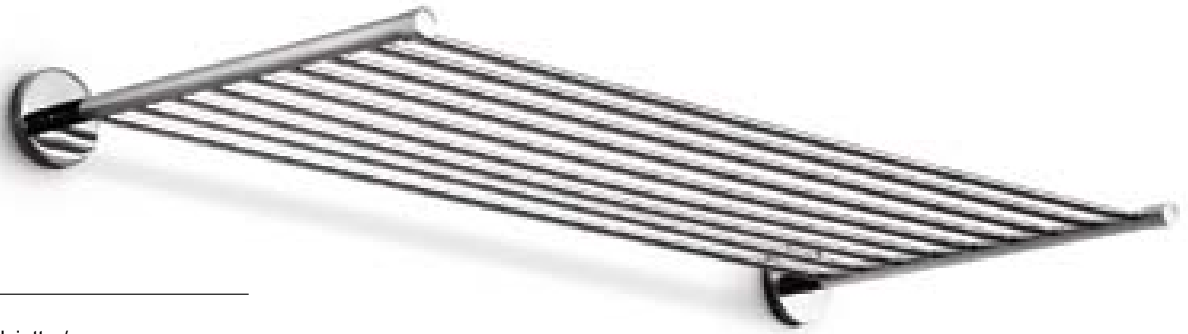



---

**5519** Griglia porta salvietta /  
*Towel shelf*  
L 620 x H 50 x P 290 mm

---

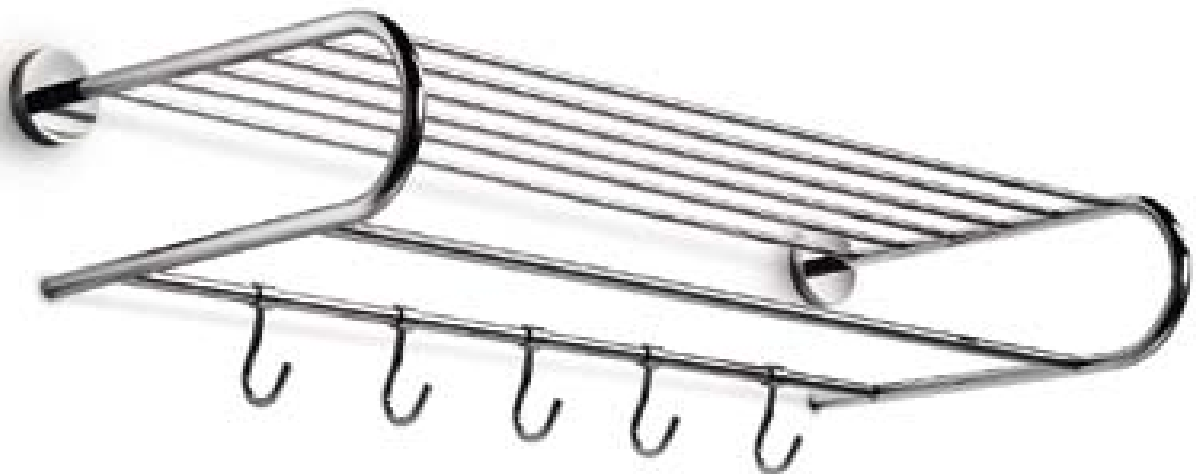

---

**5522** Griglia con porta salvietta /  
*Shelf with towel rack*  
L 650 x H 110 x P 290 mm

---



---

**5526** Coppia supporti mensola /  
*Shelf wall bearing (1 pair)*

Ø 50 x P 40 mm

---

Mensola vetro /  
*Glass shelf*

**5276.81** L 392 x H 8 x P 115 mm

**5277.81** L 492 x H 8 x P 115 mm

**5278.81** L 592 x H 8 x P 115 mm

**5279.81** L 792 x H 8 x P 115 mm

---

---

# MUCI

---

Spessori e volumi alleggeriti per puntare all'essenziale interpretato dall'ottone cromato. Coordinabili con l'omonima linea di miscelatori.

*Thicknesses and volumes have been reduced to focus on the basics interpreted by chrome-plated brass. These can be coordinated with the line of mixer taps of the same name.*

---





**55003** Bicchiere /  
*Tumbler*  
Ø 75 x H 105 mm

**55006** Spandisapone, 200 ml /  
*Soap dispenser, 200 ml*  
Ø 75 x H 175 mm

**55004** Portasapone /  
*Soap dish*  
Ø 120 x H 30 mm



**5200** Griglietta in silicone antiscivolo per  
Art. 55004 (20 pezzi assortiti in 4 colori) /  
*Silicon grid for Art. 55004*  
(20 pieces, 4 colours)  
Ø 50 x H 18 mm



**5530** Supporto singolo /  
*Single holder*  
L 90 x H 35 x P 135 mm



---

**5533**

Portarotolo /  
*Toilet paper holder*

L 144 x H 35 x P 85 mm

---



---

**5535**

Riserva rotoli /  
*Toilet paper holder*

L 35 x H 330 x P 105 mm

---

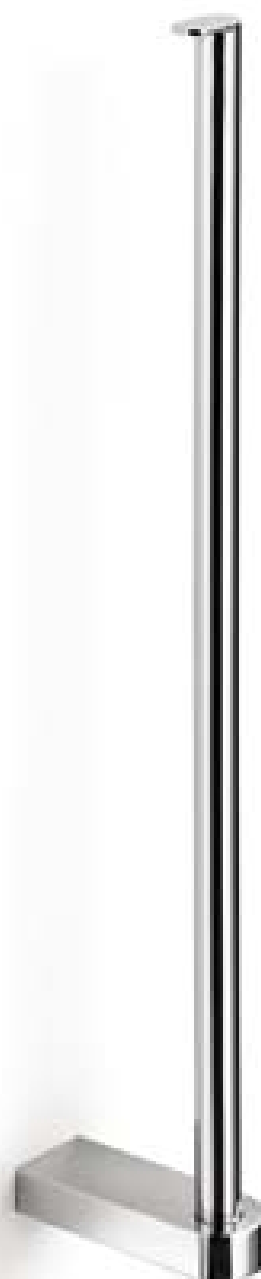



---

**5534** Portarotolo doppio /  
*Double toilet paper holder*  
L 270 x H 35 x P 85 mm

---



---

Porta salvietta /  
*Towel rail*

**5537** L 400 x H 35 x P 85 mm  
**5538** L 600 x H 35 x P 85 mm

---



---

**5539** Porta salvietta doppio snodato /  
*Double jointed towel rail*

L 380 x H 105 x P 55 mm

---



---

**5540** Anello porta salvietta /  
*Towel ring*

L 195 x H 205 x P 55 mm

---



---

**5542** Coppia appendiabiti /  
*2 hooks*

L 17 x H 35 x P 50 mm

---

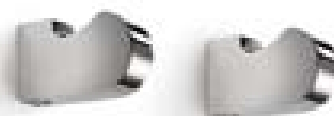



**55062** Porta scopino /  
*Toilet brush*  
Ø 90 x H 395 mm

**5536** Supporto porta scopino /  
*Toilet brush holder*  
L 110 x H 35 x P 135 mm



**5544** Coppia supporti mensola /  
*Shelf wall bearing (1 pair)*  
L 17 x H 35 x P 35 mm

Mensola vetro /  
*Glass shelf*

**5276.81** L 392 x H 8 x P 115 mm

**5277.81** L 492 x H 8 x P 115 mm

**5278.81** L 592 x H 8 x P 115 mm

**5279.81** L 792 x H 8 x P 115 mm





4022-44281-4031-4071 SAON /

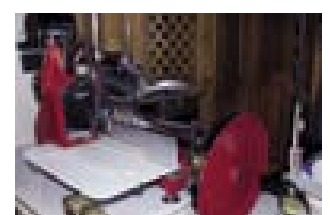
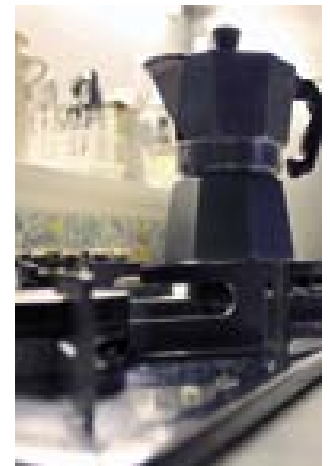

diamante beghetto's home | artist | bassano del grappa | italy

---

COLLEZIONI APPOGGIO / *TABLETOP ACCESSORIES*

---



---

# SAON

---

Semplice e rigorosa collezione di accessori da appoggio, tondi o rettangolari, realizzati in porcellana bianca e inox lucido. Completati ed arricchiti da una serie coloratissima in ABS e silicone.

*A simple and precise collection of counter accessories, round or rectangular, made from white porcelain and polished stainless steel. Completed and enhanced by a very colourful series made from ABS and silicone.*

---



**3901**



**3902**



**3903**



**3905**



**4006**



**4022**



**4023**



**4024**



**4031**



**4032**



**4033**



**4034**





**4007**



**4012**



**4013**



**4014**



**4016**



**4021**



**4041**



**4400**



**4071**



**44281**



**71901**



---

**3901** Portasapone /  
*Soap dish*  
Ø 115 x H 24 mm

---



---

**3902** Portasapone /  
*Soap dish*  
L 135 x H 23 x P 90 mm

---



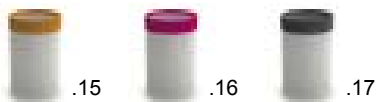

---

**3903** Bicchiere /  
*Tumbler*  
Ø 74 x H 120 mm

---



---

**3905** Spandisapone, 190 ml /  
*Soap dispenser, 190 ml*  
Ø 65 x H 178 x P 85 mm

---



---

**4006** Portasapone (4 pezzi) /  
*Soap dish (4 pieces)*

L 120 x H 30 x P 80 mm

---



---

**4007** Bicchiere (4 pezzi) /  
*Tumbler (4 pieces)*

L 60 x H 110 x P 60 mm

---



---

**4012** Bicchiere (4 pezzi) /  
*Tumbler (4 pieces)*

Ø 65 x H 105 mm

---

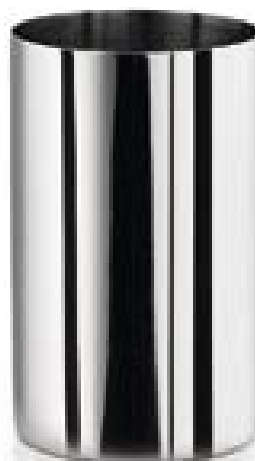

---

**4013** Portasapone (4 pezzi) /  
*Soap dish (4 pieces)*

Ø 110 x H 30 mm

---



---

**4014** Bicchiere (4 pezzi) /  
*Tumbler (4 pieces)*

Ø 72 x H 100 mm

---



---

**4016** Spandisapone, 600 ml (4 pezzi) /  
*Soap dispenser, 600 ml (4 pieces)*

Ø 80 x H 158 mm

---



---

**4021**    Bicchiere (4 pezzi) /  
          *Tumbler (4 pieces)*  
  
          Ø 80 x H 100 mm

---



---

**4022**    Porta sapone (4 pezzi) /  
          *Soap dish (4 pieces)*  
  
          Ø 115 x H 30 mm

---



---

**4023**    Spandisapone, 500 ml (4 pezzi) /  
          *Soap dispenser, 500 ml (4 pieces)*  
  
          Ø 100 x H 130 mm

---



---

**4024**    Spandisapone, 400 ml (4 pezzi) /  
          *Soap dispenser, 400 ml (4 pieces)*  
  
          Ø 80 x H 160 mm

---



---

**4031** Bicchiere (4 pezzi) /  
*Tumbler (4 pieces)*  
L 90 x H 105 x P 65 mm

---



---

**4032** Portasapone (4 pezzi) /  
*Soap dish (4 pieces)*  
L 135 x H 30 x P 90 mm

---



---

**4033** Spandisapone, 400 ml (4 pezzi) /  
*Soap dispenser, 400 ml (4 pieces)*  
L 65 x H 175 x P 65 mm

---



---

**4034** Spandisapone, 600 ml (4 pezzi) /  
*Soap dispenser, 600 ml (4 pieces)*  
L 90 x H 175 x P 65 mm

---



---

**4041** Spandisapone, 500 ml (4 pezzi) /  
*Soap dispenser, 500 ml (4 pieces)*  
L 83 x H 170 x P 73 mm

---



---

**4400** Spandisapone, 220 ml /  
*Soap dispenser, 220 ml*  
Ø 55 x H 194 mm

---

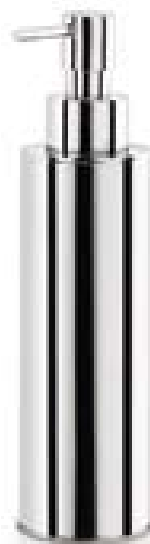

---

**4071** Bicchiere, spandisapone, portasapone /  
*Tumbler, soap dispenser, soap dish*  
Ø 80 x H 105 mm  
Ø 80 x H 150 mm  
Ø 120 x H 45 mm

---





---

**44281**    *Contenitore porta salviette /*  
*Hand towels box*  
L 200 x H 60 x P 150 mm

---



---

**71901**    *Lavetta cotone 480 g/m<sup>2</sup> (6 pezzi) /*  
*Face flannel 480 g/m<sup>2</sup> (6 pieces)*  
L 300 x P 300 mm

---





66191 ALBIO / 53265-53268 OTEL / 54231 MUCI / 53921 BUSI & CANE /

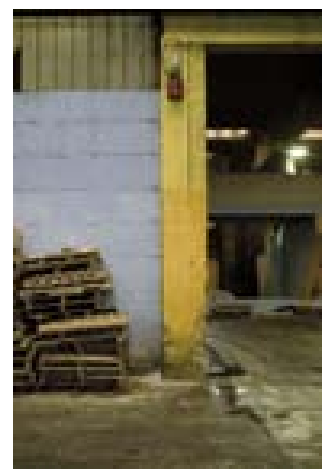
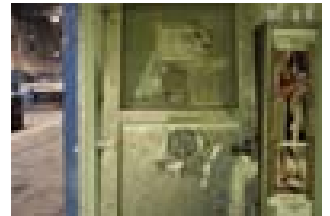

sice spa | zermeghedo | italy

---

HOTEL & CONTRACT

---



---

# OTEL

---

Collezione dai tratti contemporanei, dedicata ad accessorizzare in sicurezza i bagni delle camere d'albergo o bagni per la collettività realizzati in ottone cromato, ABS e inox.

*A collection with contemporary features, dedicated to safely accessorising hotel bathrooms or public restrooms, made from chrome-plated brass, ABS and stainless steel.*

---



**53101**



**53102**



**53103**



**53104**



**53105**



**53106**



**53261**



**53262**



**53263**



**53265**



**44095**

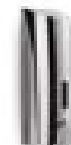

**53267**

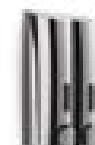

**53268**



**53292**



**53293**



**53294**



**53291**



**53295**



**53296**

---

**53101** Maniglione di sicurezza reversibile,  
con porta sapone /  
*Reversible grab security bar with  
soap holder*

L 455 x H 250 x P 110 mm

---



---

**53102** Maniglione di sicurezza reversibile /  
*Reversible grab security bar*

L 455 x H 250 x P 110 mm

---



---

**53103** Maniglione di sicurezza /  
*Grab security bar*

L 430 x Ø 57 x P 80 mm

---



---

**53104** Maniglione di sicurezza /  
*Grab security bar*

L 420 x Ø 80 x P 80 mm

---





---

**53105** Maniglione di sicurezza reversibile /  
*Corner grab security bar, reversible*  
L 800 x Ø 80 x P 620 mm

---



---

**53106** Maniglione di sicurezza ribaltabile /  
*Folding safety support*  
L 115 x H 200 x P 615 mm

---



---

**53261** Asciugacapelli a parete con presa per rasoio 110-220 V /  
*Wall hairdryer with shaver socket 110-220 V*

L 175 x H 260 x P 125 mm

---



---

**53262** Asciugacapelli a parete  
*Wall hairdryer*

L 90 x H 200 x P 160 mm

---

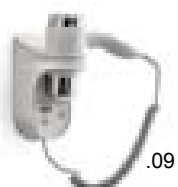

.09

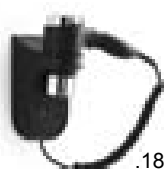

.18

---

**53263** Asciugacapelli a parete con presa per rasoio 110-220 V /  
*Wall hairdryer with shaver socket 110-220 V*

L 110 x H 255 x P 295 mm

---



**53265** Asciugamani elettrico a parete /  
*Wall hands dryer*  
L 265 x H 235 x P 165 mm



**44095** Spandisapone sottopiano, 420 ml /  
*Soap dispenser for countertop, 420 ml*  
Ø 57 x H 260 x P 110 mm



**53267** Dosatore a parete singolo 400 ml /  
*Wall bearing liquid soap dispenser 400 ml*  
L 75 x H 245 x P 70 mm



**53268** Dosatore a parete doppio 800 ml /  
*Double wall bearing liquid soap dispenser 800 ml*  
L 135 x H 245 x P 70 mm



---

**53292** Distributore jumbo carta igienica /  
*Jumbo roll toilet tissue dispenser*  
L 260 x H 265 x P 130 mm

---



---

**53293** Porta sacchetti igienici /  
*Sanitary bag holder*  
L 130 x H 280 x P 60 mm

---



---

**53294** Distributori asciugamani di carta /  
*Paper towels dispenser*  
L 280 x H 365 x P 100 mm

---



---

**53291** Porta salviette /  
*Tissue container*  
L 265 x H 140 x P 55 mm

---



---

**53295** Filo stendibiancheria 250 mm /  
*Retractable clothesline 250 mm*  
Ø 92 x P 50 mm - L 33 x H 66 mm

---



---

**53296** Apri bottiglie /  
*Bottle opener*  
L 42 x H 95 x P 30 mm

---





51195 RANPIN / 53261 OTEL / 54703 SCAGNI / 71910 TAPEI /



silvano marchetto's home | entrepreneur | arzignano | italy

---

## PIANTANE & STANDS

---



**RANPIN**

*piantane / floor stands*

**122** PRICELIST **77**

---

---

# RANPIN

---

Sistema di piantane polifunzionali in ottone cromato, in diverse altezze, attrezzabili in coordinato con la collezione 'BAKETO'.

*A system of multi-functional floor stands in chrome-plated brass, of various heights, which can be equipped to match the 'BAKETO' collection.*

---

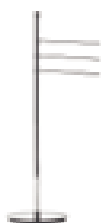

**5120**



**5124**



**51259**



**51239**



**5126**

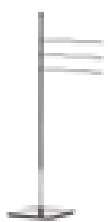

**51191**



**51193**



**51194**



**51192**



**51195**

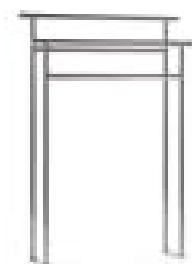

**5128**

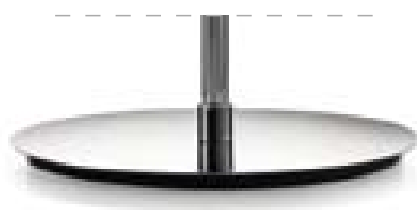

Base circolare / *Circular base*

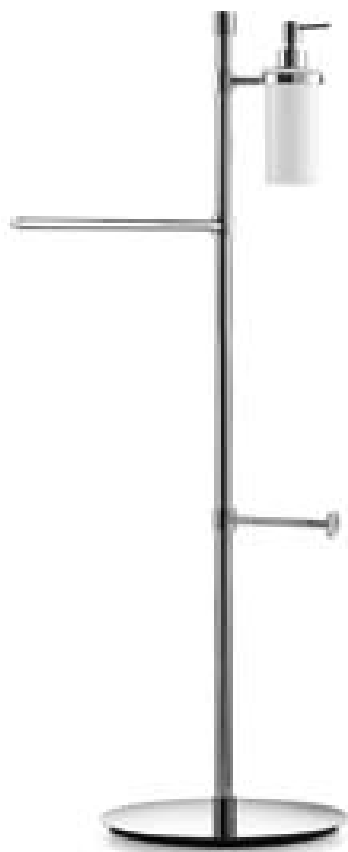

Piantana attrezzata /  
*Accessoried stand*

**51239** Piantana alta attrezzabile /  
*Accessories stand, tall*

**52241** Supporto per barra /  
*Single holder for rail*

**55006** Spandisapone, 200 ml /  
*Soap dispenser, 200 ml*

**5229** Porta salvietta per barra /  
*Towel rail for rail*

**5226** Portarotolo per barra /  
*Toilet paper holder for rail*

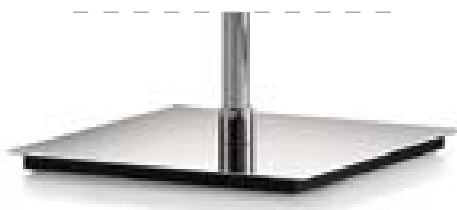

Base quadrata / *Square base*



Piantana attrezzata /  
*Accessoried stand*

**51192** Piantana alta attrezzabile /  
*Accessories stand, tall*

**52261** Appendino doppio per barra /  
*Double hook for rail*

**52271** Supporto scopino per barra /  
*Toilet brush holder for rail*

**55062** Porta scopino /  
*Toilet brush*

---

**5120** Piantana con 3 portasalvietta /  
*Towel-stand, 3 arms*

Ø 275 x H 910 x P 450 mm

---

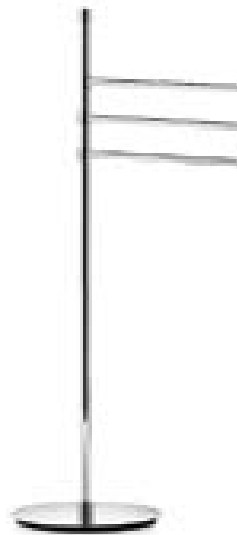

---

**5124** Piantana con porta rotolo e porta scopino /  
*Toilet paper and brush holder stand*

Ø 193 x H 665 x P 260 mm

---



---

**51259** Piantana bassa attrezzabile /  
*Accessories stand, low*

Ø 193 x H 665 mm

---

Combinabile con serie 'BAKETO' /  
*Matching with 'BAKETO' range*

---



---

**51239** Piantana alta attrezzabile /  
*Accessories stand, tall*  
Ø 275 x H 910 mm

---

Combinabile con serie 'BAKETO' /  
*Matching with 'BAKETO' range*

---



---

**5126** Piantana appendiabiti /  
*Hooks-stand*  
Ø 275 x H 1800 mm

---

Combinabile con serie 'BAKETO' /  
*Matching with 'BAKETO' range*

---

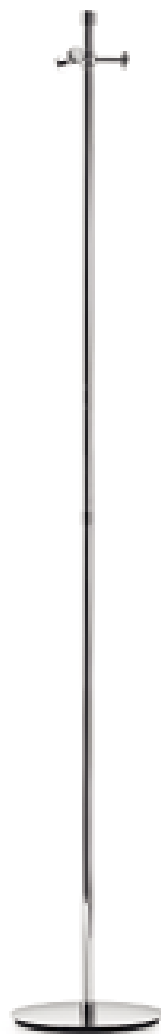

---

**51191** Piantana con 3 portasalvietta /  
*Towel-stand, 3 arms*

L 230 x H 910 x P 430 mm

---



---

**51193** Piantana con porta rotolo e porta scopino /  
*Toilet paper and brush holder stand*

L 170 x H 660 x P 260 mm

---



---

**51194** Piantana bassa attrezzabile /  
*Accessories stand, low*

L 170 x H 660 x P 170 mm

---

Combinabile con serie 'BAKETO' /  
*Matching with 'BAKETO' range*

---



---

**51192** Piantana alta attrezzabile /  
*Accessories stand, tall*  
L 230 x H 910 x P 230 mm

---

Combinabile con serie 'BAKETO' /  
*Matching with 'BAKETO' range*

---



---

**51195** Piantana appendiabiti /  
*Hooks-stand*  
L 230 x H 1800 x P 230 mm

---

Combinabile con serie 'BAKETO' /  
*Matching with 'BAKETO' range*

---

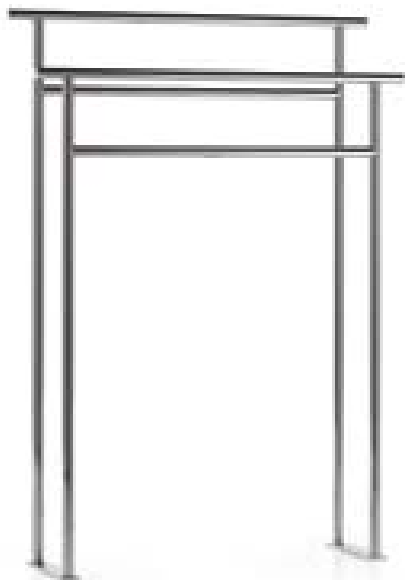

---

**5128** Piantana portasalvietta /  
*Towel rack*  
L 650 x H 910 x P 170 mm

---

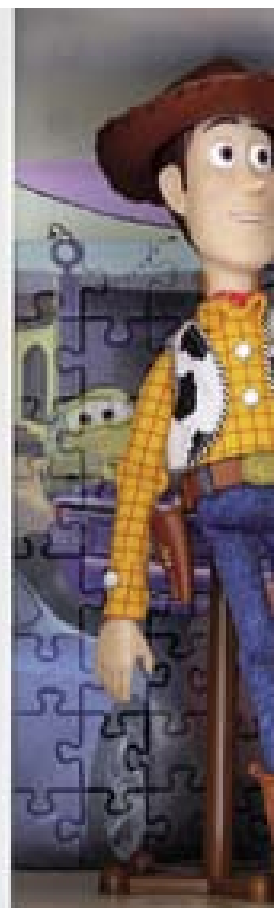

5010-5017 SKOATI /



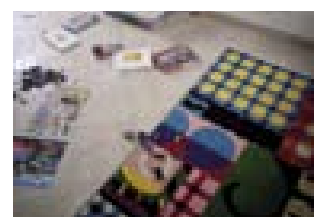

tobia antonello's home | kid | camisano | italy

---

SCOPINI / *BRUSH HOLDERS*

---

SKOATI

scopini / *toilet brush holders*

132 PRICELIST 83

---

---

# SKOATI

---

design **Roy Frame**

Collezione di porta scopini a parete e a pavimento, realizzati in inox lucido, ABS e silicone. Accanto ai modelli dalle forme più tradizionali ne troviamo alcuni più ironici e divertenti.

*A collection of wall-mounted or standing toilet brush stands, made from polished stainless steel, ABS and silicone. Next to our more traditionally-shaped models we have other more ironic and fun styles.*

---



5004

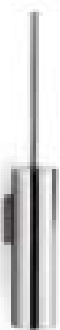

50041



50051



50053



50203



50207



5008



5010



5011



5012

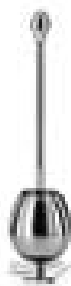

5013



5014



5015



5016



5017



---

**5004** Porta scopino da pavimento /  
*Toilet brush holder*  
Ø 80 x H 540 mm

---

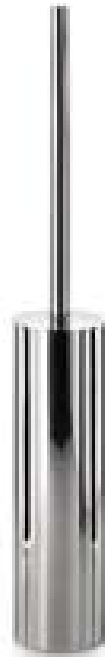

---

**50041** Porta scopino a parete /  
*Wall toilet brush holder*  
Ø 80 x H 540 X P 90 mm

---

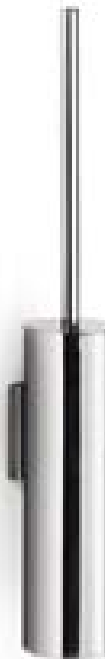

---

**50051** Porta scopino quadro da pavimento /  
*Square toilet brush holder*  
L 85 x H 540 x P 85 mm

---



---

**50053** Porta scopino quadro a parete /  
*Wall square toilet brush holder*  
L 85 x H 540 x P 90 mm

---

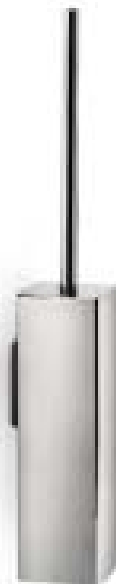



---

**50203** Porta scopino da pavimento /  
*Toilet brush holder*  
Ø 93 x H 450 mm

---



---

**50207** Porta scopino da pavimento /  
*Toilet brush holder*  
Ø 90 x H 370 mm

---

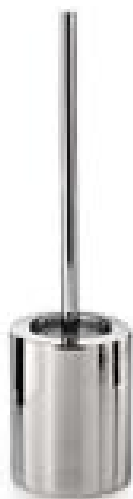

---

**5008** Porta scopino da pavimento /  
*Toilet brush holder*  
Ø 110 x H 390 mm

---



---

**5010** Porta scopino 'BAJLE' /  
*Toilet brush holder 'BAJLE'*  
Ø 110 x H 460 mm

---



---

**5011** Porta scopino 'BUTTO' /  
*Toilet brush holder 'BUTTO'*  
Ø 125 x H 475 mm

---



---

**5012** Porta scopino 'PESSE' /  
*Toilet brush holder 'PESSE'*  
L 150 x H 470 x P 200 mm

---

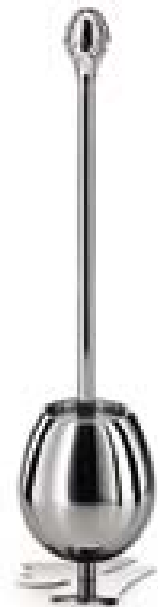

---

**5013** Porta scopino 'VOVO' /  
*Toilet brush holder 'VOVO'*  
Ø 115 x H 455 mm

---





---

**5014** Porta scopino 'LONGA' /  
*Toilet brush holder 'LONGA'*  
Ø 90 x H 550 mm

---



---

**5015** Porta scopino 'CALA' /  
*Toilet brush holder 'CALA'*  
Ø 115 x H 420 mm

---



---

**5016** Porta scopino 'RACOLA' /  
*Toilet brush holder 'RACOLA'*  
Ø 90 x H 445 mm

---



---

**5017** Porta scopino 'ROBO' /  
*Toilet brush holder 'ROBO'*  
L 140 x H 400 x P 120 mm

---



53559 MOMON / 54231 MUCI / 55860 MEVEDO / 57016 CIARI / 71910 TAPEI / 8010-8015 BEJ /

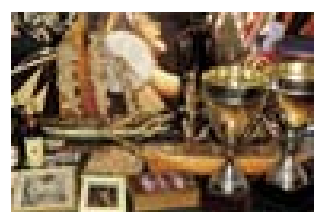
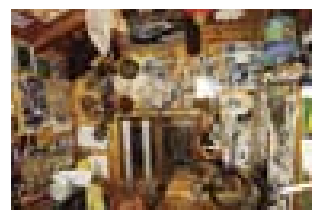
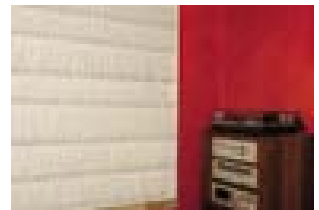

marco chiurato's home | artist | marostica | italy

---

*LAVABI / WASHBASINS*

---

<b>MOMON</b>	lavabi mattstone / <i>mattstone washbasins</i>	<b>142</b>	PRICELIST	89
<b>ACQUAIO</b>	vasche / <i>washbasins</i>	<b>146</b>	PRICELIST	92
<b>QUARELO</b>	lavabi ceramica / <i>ceramic washbasins</i>	<b>152</b>	PRICELIST	96
<b>BOLE</b>	mensole TOP in resina acrilica / <i>acrylic resin shelf TOP</i>	<b>154</b>	PRICELIST	97
<b>ALBIO</b>	vasche con supporto / <i>washbasins with wall bearing</i>	<b>156</b>	PRICELIST	98
<b>GOTO</b>	set supporto vasche / <i>wall bearing set</i>	<b>158</b>	PRICELIST	99
<b>CIUCI</b>	lavamani in mattstone con supporto / <i>mattstone handrinse basin</i>	<b>160</b>	PRICELIST	101
<b>POCIA</b>	vasche vetro / <i>glass washbasins</i>	<b>162</b>	PRICELIST	102
<b>LISSIO</b>	consolle lavabo / <i>frame with washbasin top</i>	<b>164</b>	PRICELIST	103

---

# MOMON

---

Serie di lavabi dalle linee essenziali, tonde o squadrate in mattstone bianco, che è materiale sintetico, solido e resistente, non poroso, quindi molto igienico. Disponibili nelle varianti da appoggio, a muro o free standing.

*A series of wash basins with basic, round or square lines in white Mattstone, which is a synthetic, solid and resistant, non-porous material and therefore very hygienic. Available in the variations to be mounted on a stand, wall-mounted or free-standing.*

---



**53553**



**53554**



**53555**



**53556**



**5353557**



**53558**



**53559**



---

Lavabo da appoggio, completo di piletta a scarico libero  
e copri piletta in mattstone /  
*Countertop washbasin, with waste water drain  
and mattstone cover*

**53553** L 480 x H 120 x P 360 mm

**53554** L 680 x H 120 x P 360 mm

---



---

Lavabo a muro o da appoggio con foro rubinetto, completo  
di piletta e copri piletta mattstone /  
*Wall hand/countertop washbasin with waste water drain  
and mattstone cover*

**53555** L 480 x H 120 x P 430 mm

**53556** L 680 x H 120 x P 430 mm

---

---

**53557** Lavabo da appoggio senza troppopieno, completo di piletta e copri piletta mattstone /  
*Countertop washbasin, with waste water drain and mattstone cover, without overflow*

L 260 x H 120 x P 400 mm

---



---

**53558** Lavabo rotondo da appoggio con foro rubinetto, completo di piletta e copri piletta mattstone /  
*Countertop round washbasin, with waste water drain and mattstone cover*

Ø 455 x H 120 mm

---





---

**53559** Lavabo centro stanza con foro rubinetto, completo di piletta  
e copri piletta mattstone /  
*Pedestal washbasin, with waste water drain and  
mattstone cover*

Ø 455 x H 900 mm

---



---

# ACQUAIO

---

Serie di lavabi in inox lucido, bambù, vetro stratificato e temperato o ceramica. I modelli in vetro sono disponibili con particolari finiture come la foglia d'oro o argento che riescono a trasformare la toilette quotidiana in un momento piacevole e festoso.

*A series of wash basins in polished stainless steel, bamboo, layered and tempered glass or ceramic. The glass models are available with special gold or silver leaf finishes that transform daily grooming activities into a pleasant and festive moment.*

---



53586



53596



53666



53593



53663



53694



53695



53696



53697



53698



53699



53715



53716



53718



53719

---

Vasca senza bordo, da appoggio /  
*Washbasin, without edge*

**53586** Ø 245 x H 120 mm

**53596** Ø 440 x H 130 mm

**53666** Ø 390 x H 145 mm

---



---

Vasca con bordo piatto /  
*Washbasin with flat edge*

**53593** Ø 330 x H 135 mm

**53663** Ø 290 x H 165 mm

---





---

**53694** Vasca da appoggio /  
*Countertop washbasin*  
Ø 430 x H 160 mm

---



---

**53695** Vasca con ghiera fissaggio /  
*Washbasin with fixing ring*  
Ø 300 x H 110 mm

---



**53696** Vasca con ghiera fissaggio /  
*Washbasin with fixing ring*

Ø 425 x H 140 mm



**53697** Vasca ovale con ghiera fissaggio /  
*Oval washbasin with fixing ring*

L 580 x H 120 x P 350 mm



---

Vasca tonda, senza piletta /  
*Round washbasin, without waste water drain*

**53698**    Ø 295 x H 100 mm

**53699**    Ø 430 x H 130 mm

---



---

**53715**    Lavabo ovale, senza piletta /  
*Oval washbasin, without waste water drain*

L 583 x H 130 x P 363 mm

---



---

**53716** Lavabo, senza piletta /  
*Washbasin, without waste water drain*  
L 475 x H 130 x P 370 mm

---



---

Lavabo, senza piletta /  
*Washbasin, without waste water drain*  
**53718** L 500 x H 110 x P 380 mm  
**53719** L 650 x H 110 x P 380 mm

---

---

# QUARELO

---

Serie di lavabi in ceramica bianca, le sue forme essenziali lo rendono adatto a qualsiasi ambiente. Disponibile nelle versioni da appoggio o a muro.

*A series of white ceramic wash basins. Its basic shapes make it suitable for any style of setting. Available in versions with a stand or wall-mounted.*

---



**53706**



**53708**



**53709**



**53710**

---





---

**53706** Lavabo a muro con piletta scarico libero  
Art. 53971, senza troppopieno /  
*Wall washbasin with free waste water drain*  
Art. 53971, without overflow  
  
L 330 x H 115 x P 290 mm

---

Disponibile con foro o senza foro per rubinetto /  
*Available with or without hole for tap*

---



---

Lavabo da appoggio o sospeso a muro,  
senza piletta /  
*Wall hand/countertop washbasin without*  
*waste water drain*

---

**53708** L 430 x H 130 x P 365 mm  
**53709** L 495 x H 125 x P 415 mm  
**53710** L 700 x H 130 x P 420 mm

---

Disponibile con foro o senza foro per rubinetto /  
*Available with or without hole for tap*

---

---

# BOLE

---

Piano d'appoggio per lavabo dalla forma essenziale realizzato nell'innovativo materiale Hanex® bianco con staffe in acciaio che consentono un solido fissaggio a muro.

*Washbasin top designed with essential shape, realized in the innovative white Hanex® material with steel clamps that allows a strong wall attachment.*

---



---

Piano in resina acrilica con supporti a muro /  
*Acrylic resin shelf top with wall brackets*

<b>6610</b>	L 800 x H 60 x P 500 mm
<b>6611</b>	L 1000 x H 60 x P 500 mm
<b>6612</b>	L 1300 x H 60 x P 500 mm

---

---

# ALBIO

---

Vasche circolari in acciaio inox lucido, antibatterico, resistente al tempo e all'azione corrosiva dell'acqua. Con piletta a scarico libero e sifone a vista.

*Round basins in polished stainless steel, antibacterial, resistant to time and the corrosive action of water. With free flow drain and visible trap.*

---



**66171**



**66191**

---

Vasca con supporto, pileta scarico libero Art. 53971,  
sifone Art. 53921 /  
*Washbasin with wall bearing, free waste water drain  
Art. 53971, siphon Art. 53921*

**66171**    Ø 290 x H min 430 - max 480 x P 365 mm

**66191**    Ø 390 x H min 430 - max 480 x P 495 mm

---

Disponibile con foro o senza foro per rubinetto /  
*Available with or without hole for tap*

---



---

# GOTO

---

Set di supporto con o senza foro rubinetto per vasche in acciaio o vetro, complete di piletta e sifone in ottone cromato.

*Set of supports with or without a hole for the tap, for stainless steel or glass basins, complete with chrome-plated brass drain and trap.*

---



**66201**



**66211**



**66202**



**66212**

---

Set supporto vasca con foro rubinetto, piletta  
 Art. 53972 e sifone Art. 53921 /  
*Wall bearing, with hole for tap, free waste water  
 drain Art. 53972, siphon Art. 53921*

**66201** L 84 x H min 260 - max 310 x P 265 mm

**66211** L 104 x H min 260 - max 310 x P 345 mm

---



---

Set supporto vasca senza foro rubinetto, piletta  
 Art. 53972 e sifone Art. 53921 /  
*Wall bearing, without hole for tap, free waste  
 water drain Art. 53972, siphon Art. 53921*

**66202** L 83 x H min 170 - max 220 x P 235 mm

**66212** L 104 x H min 170 - max 220 x P 325 mm

---



---

# CIUCI

---

Lavamani piccolo e versatile consente l'installazione anche in spazi ridotti. Realizzato in mattstone e si accompagna a dei supporti coloratissimi.

*A small and versatile wash basin that can even be installed in tight spaces. Made from mattstone, and mounted on very colourful supports.*

---





---

**6622**

Lavamani con supporto, piletta scarico libero  
Art. 53971, sifone Art. 53922 /  
*Handrinse basin with wall bearing, free waste  
water drain Art. 53971, siphon Art. 53922*

L 350 x H min 235 - max 323 x P 315 mm

---

---

# POCIA

---

Collezione di lavabi rettangolari in vetro in varie finiture, incastonati in una struttura in acciaio inox con barra portasciugamani.

*A collection of rectangular glass wash basins in various finishes, mounted on stainless steel frames with towel racks.*

---

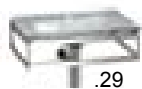

.29



.30



.83



.85



.87



.89

**66580**

Lavamani con piletta Art. 53971  
e sifone Art. 53922 /  
*Washbasin with waste water drain Art. 53971  
and siphon Art. 53922*

L 510 x H min 305 - max 425 x P 355 mm



.29



.30



.83



.85



.87

**665811**

Lavamani con piletta Art. 53971 e sifone  
Art. 53922, DX o SX /  
*Washbasin with waste water drain Art. 53971  
and siphon Art. 53922, DX or SX*

L 450 x H min 310 - max 430 x P 260 mm

Con foro per rubinetto DX o SX /  
*With hole for tap DX or SX*

---

# LISSIO

---

Top lavabo in ceramica dagli spessori ridotti e bordi piano sottili. Un design altamente razionale per la console in metallo verniciato a polvere, disponibile nei colori. Bianco, arancione, antracite e ruggine.

*Ceramic wash basin top with reduced thickness and thin counter edges. A highly rational design for the powder-coated metal console, available in the following colours: white, orange, anthracite and rust.*

---



.09



.14

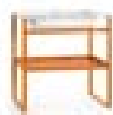

.15



.17

---

**6661**

Consolle verniciata a polvere, top lavabo in ceramica /  
*Powder painted frame with ceramic washbasin top*

L 900 x H 900 x P 460 mm

---



53922 BUSI & CANE / 54231 MUCI / 5673 SPECI / 6622 CIUCI /

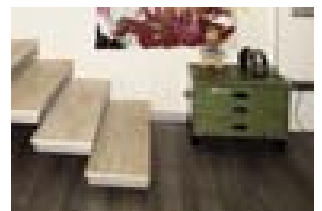

eddy antonello's home | prototyper | camisano | italy

---

RUBINETTERIA / *TAPS & FITTINGS*

---



<b>BUSI &amp; CANE</b>	sifoni e pilette / <i>siphons and water drains</i>	<b>170</b>	PRICELIST 105
<b>LINEA</b>	rubinetti / <i>taps</i>	<b>174</b>	PRICELIST 109
<b>CRUI</b>	rubinetti / <i>taps</i>	<b>186</b>	PRICELIST 117
<b>MUCI</b>	rubinetti / <i>taps</i>	<b>192</b>	PRICELIST 120

---

# BUSI & CANE

---

Raccordi, sifoni, pilette e ghiera in ottone cromato. Ideali per ogni tipo di ambiente: moderno, elegante, raffinato e minimal. Attenzione e cura per prodotti, che normalmente si tendono a nascondere..

*Chrome-plated brass fittings, traps, drains and ring nuts. Ideal for every type of style: modern, elegant, sophisticated and minimal. A focus and attention to products that are usually kept hidden.*

---



5389



5392



53921

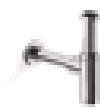

53922



53925



53926



53927



5398



53960



53961



53971 - 53972 - 53975



53991 - 53992



53993 - 53994 - 53995

---

**5389** Raccordo T 2 vie, 1"-1/4 mm /  
*T pipe-union, 1" 1/4 mm*  
L max 740 x H 80 x P Ø 45 mm



**5392** Sifone, 1"-1/4 mm /  
*Siphon, 1" 1/4 mm*  
Ø 44 x H min 90 - max 190 x P max 290 mm



**53921** Sifone salvaspazio, 1"-1/4 mm /  
*Space saving siphon, 1" 1/4 mm*  
Ø 50 x H min 170 - max 220 x P min 170 - max 360 mm



**53922** Sifone, 1"-1/4 mm /  
*Siphon, 1" 1/4 mm*  
Ø 50 x H min 65 - max 160 x P max 290 mm



**53925** Sifone, 1"-1/4 mm /  
*Siphon, 1" 1/4 mm*  
Ø 45 x H min 65 - max 160 x P max 290 mm



---

**53926** Sifone per bidet, 1"-1/4 mm /  
*Bidet siphon, 1" 1/4 mm*  
Ø 50 x H min 60 - max 120 x P max 290 mm

---



---

**53927** Sifone salvaspazio, 1"-1/4 mm /  
*Space saving siphon, 1" 1/4 mm*  
L 32 x H max 380 x P max 350 mm

---



---

**5398** Ghiera appoggio vasche sopra piano /  
*Support nut for washbasin*  
Ø 63 x H 12 mm

---



---

**53960** Piletta a pavimento, click clack,  
con cestello e scarico verticale /  
*Automatic floor waste water drain,  
with drum and vertical drain*  
L 100 x H 42 X P 100 mm

---



**53961** Piletta automatica click regolabile  
 0-60 mm, 1"-1/4 mm /  
*Automatic waste water drain for basin,  
 height from 0 to 60 mm , 1" 1/4 mm*  
 Ø 42 x H max 60 mm



Piletta scarico libero, 1"-1/4 mm /  
*Free waste water drain for basin,  
 1" 1/4 mm*

**53971** Ø 42 x H max 30 mm

**53972** Ø 42 x H max 50 mm

**53975** Ø 42 x H max 80 mm



Piletta automatica click con troppopieno /  
*Automatic waste water drain for basin,  
 with overflow*

**53991** Ø 42 x H max 50 mm

**53992** Ø 42 x H max 80 mm



Piletta automatica click senza troppopieno /  
*Automatic waste water drain for basin,  
 without overflow*

**53993** Ø 42 x H max 30 mm

**53994** Ø 42 x H max 50 mm

**53995** Ø 42 x H max 80 mm



---

# LINEA

---

Forme semplici e cilindriche e design essenziale per questa collezione di miscelatori in ottone cromato.

*Simple and cylindrical shapes and basic design for this collection of chrome-plated brass mixer taps.*

---



5401

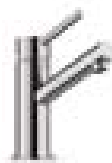

5402



54011



5404



5403

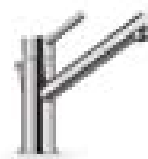

5405



5408



54031 - 54032



54123



54125



54131



54132



54133



54291



54292



5410



5411



5412



54122

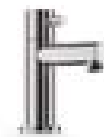

5417



54061



5414



54198



54199



54203



54204



54201



54206



54207



54208



54209

---

**5401** Miscelatore monocomando lavabo /  
*Single hole mixer without pop-up*  
Ø 46 x H 186 x P 160 mm

---



---

**5402** Miscelatore monocomando lavabo /  
*Single hole mixer without pop-up*  
Ø 55 x H 193 x P 160 mm

---



---

**54011** Prolunga per miscelatore lavabo /  
*Mixer extension*  
Ø 36 x H 100 mm

---





**5404** Miscelatore monocomando lavabo, con saltarello /  
*Single hole mixer with pop-up*  
 Ø 55 x H 193 x P 175 mm



**5403** Miscelatore monocomando lavabo, canna lunga /  
*Single hole mixer, long spout, without pop-up*  
 Ø 55 x H 193 x P 250 mm



**5405** Miscelatore monocomando lavabo, canna lunga, con saltarello /  
*Single hole mixer, long spout, with pop-up*  
 Ø 55 x H 193 x P 260 mm



---

**5408** Miscelatore monocomando bidet, con saltarello /  
*Bidet mixer with pop-up*  
Ø 55 x H 193 x P 150 mm

---



---

Prolunga per miscelatore lavabo /  
*Mixer extension*

**54031** Ø 45 x H 100 mm

**54032** Ø 45 x H 50 mm

---



---

**5410** Miscelatore vasca esterno /  
*External bath group*

L 280 x H 90 x P 205 mm

---



**5411** Miscelatore vasca esterno, con deviatore e duplex doccetta /  
*External bath group, with diverter and hand shower set*  
 L 280 x H 90 x P 205 mm



**5412** Miscelatore monocomando doccia ad incasso /  
*Shower built-in mixer*  
 Ø 115 x P min 62 - max 70 mm



**54122** Canna a muro per lavabo /  
*Washbasin spout*  
 Ø 60 x P min 200 - max 210 mm



---

**5417**    Rubinetto acqua fredda /  
*Cold water mixer*

Ø 46 x H 144 x P 120 mm

---



---

**54061**    Miscelatore monocomando 2 fori per piano, canna alta, testa cieca /  
*Counter spout mixer; without pop-up*

Ø 40 x H 60 mm (miscelatore / mixer)  
H 323 x P 150 mm (canna / spout)

---



**5414** Miscelatore 3 fori a muro ad incasso /  
*3 holes built-in mixer for washbasin*  
 Ø 60 x P 230 mm



**54123** Miscelatore monocomando doccia ad incasso,  
 con deviatore /  
*Built-in mixer with diverter*  
 Ø 190 x P 52 mm



**54125** Miscelatore monocomando doccia termostatico ad  
 incasso, con deviatore /  
*Built-in thermostatic mixer with diverter*  
 Ø 200 x P 57 mm



---

**54131** Miscelatore monocomando doccia esterno /  
*External shower mixer*

L 280 x H 65x P 140 mm

---



---

**54132** Miscelatore monocomando doccia esterno, con flessibile doccia /  
*External shower mixer, with hand shower set*

L 280 x H 65 x P 140 mm

---



---

**54133** Miscelatore termostatico monocomando doccia esterno /  
*Thermostatic external shower mixer*

L 313 x H 60 x P 102 mm

---



---

**54291** Miscelatore monocomando cucina /  
*Kitchen mixer*  
Ø 60 x H 335 x P 220 mm

---



---

**54292** Miscelatore monocomando cucina, professionale,  
con doccetta 2 getti /  
*Professional kitchen mixer, with 2 jets hand shower*  
Ø 60 x H 535 x P 310 mm

---



---

**54198** Presa acqua con supporto doccetta, uscita 1/2" M /  
*Water intake with shower hook, with 1/2" M connection*  
Ø 45 x H 50 x P 99 mm

---



---

**54199** Presa acqua con supporto doccetta, uscita 1/2" M /  
*Water intake with shower hook, with 1/2" M connection*  
Ø 45 x H 50 x P 99 mm

---



---

**54203** Curvetta di raccordo a muro, uscita 1/2" M /  
*Elbow connection, with 1/2" M connection*  
Ø 42 x H 48 x P 80 mm

---



---

**54204** Curvetta di raccordo a muro, uscita 1/2" M /  
*Elbow connection, with 1/2" M connection*  
Ø 42 x H 45 x P 80 mm

---





**54201** Rubinetto arresto sottolavabo con filtro, uscita 1/2" M /  
*Stop cock valve with filter, 1/2" M connection*  
 Ø 55 x H 75 x P 100 mm



**54206** Rubinetto arresto sottolavabo 1/2" M, con ogiva per tubetti /  
*Stop cock valve 1/2" M, with connection for tubes*  
 Ø 52 x H 75 x P 80 mm



**54207** Rubinetto arresto sottolavabo 1/2" M, con ogiva per tubetti /  
*Stop cock valve 1/2" M, with connection for tubes*  
 Ø 52 x H 76 x P 80 mm



**54208** Rubinetto arresto sottolavabo, 1/2" M uscita 3/8" /  
*Stop cock valve 1/2" M connection 3/8"*  
 Ø 52 x H 65 x P 80 mm



**54209** Rubinetto arresto sottolavabo, 1/2" M uscita 3/8" /  
*Stop cock valve 1/2" M connection 3/8"*  
 Ø 52 x H 54 x P 80 mm



---

# CRUI

---

Serie di miscelatori in ottone cromato a sezione quadrata dalle linee decise e il design di tendenza.

*A series of mixer taps with a square cross-section, clean lines and trendy design. In chrome-plated brass.*

---



54211



54212



54214



54213



54216



54221

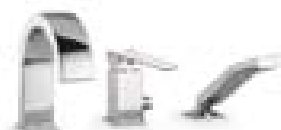

54222



54223



54224



54225

---

**54211** Miscelatore monocomando lavabo /  
*Single hole mixer without pop-up*  
L 45 x H 134 x P 162 mm

---



---

**54212** Miscelatore monocomando lavabo, con saltarello /  
*Single hole mixer with pop-up*  
L 45 x H 134 x P 170 mm

---



---

**54214** Miscelatore monocomando bidet, con saltarello /  
*Bidet mixer with pop-up*

L 45 x H 134 x P 157 mm

---



---

**54213** Miscelatore monocomando lavabo alto /  
*High single lever washbasin mixer without pop-up*

L 45 x H 312 x P 235 mm

---



---

**54216** Miscelatore lavabo incasso con bocca piatta e piastra rettangolare /  
*Single level basin mixer with flat spout and rectangular wall plate*  
L 250 x H 90 x P 175 mm

---



---

**54221** Miscelatore vasca esterno, con duplex doccetta /  
*External bath group with hand shower set*  
L 270 x H 60 x P 170 mm

---





---

**54222** Miscelatore bordo vasca, con deviatore e duplex doccia /  
*Bath group with diverter and hand shower set*

L 45 x H 190 x P 241 mm

---

---

**54223** Miscelatore monocomando doccia incasso /  
*Shower built-in mixer*

L 110 x H 110 x P 57 mm

---



---

**54224** Miscelatore monocomando doccia incasso con deviatore /  
*Shower built-in mixer with diverter*

L 120 x H 190 x P 57 mm

---



---

**54225** Miscelatore monocomando doccia esterno /  
*External shower mixer*

L 272 x H 60 x P 87 mm

---



---

# MUCI

---

Miscelatori in ottone cromato. Minimalismo estetico, ampie superfici piane in un unico oggetto, dai tratti morbidi ed eleganti.

*Chrome-plated brass mixer taps. Aesthetic minimalism, broad flat surfaces on a single object, with soft and elegant features.*

---

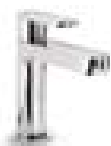

54231



54232

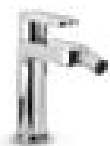

54233



54234



54237



54241



54242



54244



54246



54247



54249



54250



54245



---

**54231** Miscelatore monocomando lavabo /  
*Single hole mixer without pop-up*  
Ø 48 x H 142 x P 150 mm

---



---

**54232** Miscelatore monocomando lavabo, con piletta automatica click  
Art. 53991 /  
*Single hole mixer with automatic waste water drain*  
Art. 53991  
Ø 48 x H 142 x P 150 mm

---



---

**54233** Miscelatore monocomando bidet, con piletta automatica click  
Art. 53991 /  
*Bidet mixer with automatic waste water drain*  
Art. 53991

Ø 48 x H 142 x P 130 mm

---



---

**54234** Miscelatore monocomando lavabo, alto /  
*High single lever washbasin mixer without pop-up*

Ø 48 x H 295 x P 200 mm

---



---

**54237** Miscelatore monocomando lavabo incasso, con bocca,  
piastra a 2 fori /  
*Built-in single hole basin mixer, with spout and 2 holes plate*  
L 230 x H 120 x P 210 mm

---



---

**54241** Miscelatore monocomando doccia ad incasso /  
*Shower built-in mixer*  
L 110 x H 200 x P 46 mm

---



---

**54242** Miscelatore monocomando doccia ad incasso, con deviatore /  
*Built-in mixer, with diverter*  
L 110 x H 200 x P 60 mm

---



---

**54244** Miscelatore monocomando doccia esterno /  
*External shower mixer*  
L 200 x H 64 x P 140 mm

---



---

**54246** Miscelatore vasca esterno /  
*External bath group*

L 200 x H 57 x P 175 mm

---



---

**54247** Miscelatore vasca esterno, con flessibile e doccetta /  
*External bath group, with diverter and hand shower set*

L 200 x H 64 x P 173 mm

---



---

**54249** Doccetta per sanitari con supporto a muro /  
*WC hand shower with wall support*

Ø 34 x H 160 x P 50 mm

---





---

**54250** Rubinetto acqua fredda /  
*Cold water mixer*  
Ø 48 x H 327 x P 225 mm

---

---

**54245** Colonna doccia con miscelatore esterno, deviatore, doccetta  
cilindrica e flessibile /  
*Shower column with external mixer, with diverter, flexible  
and antilimestone and shower*

L 200 x H min 1000 - max 1300 x P 400 mm

---





51191 RAMPIN / 54703 SCAGNI / 53829 SUPIONI /

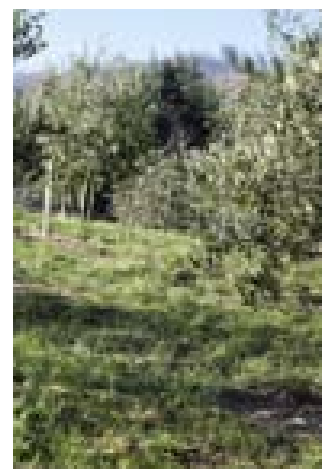
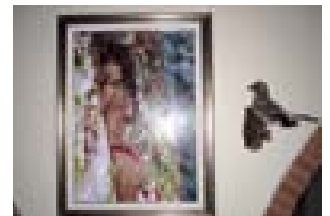

silvano marchetto's home | entrepreneur | arignano | italy

---

DOCCIA / *SHOWER*

---



<b>FILO</b>	portaoggetti doccia / <i>shower trays</i>	<b>202</b>	PRICELIST 125
<b>SUPIONI</b>	soffioni & Co. / <i>shower heads &amp; Co.</i>	<b>206</b>	PRICELIST 129
<b>LINEA DOCCIA</b>	supporti doccia / <i>rails &amp; Co.</i>	<b>212</b>	PRICELIST 134
<b>ATLANTICA</b>	pedane doccia / <i>shower wood mats</i>	<b>218</b>	PRICELIST 139

---

# FILO

---

Pratiche griglie portaoggetti per la doccia che sposano eleganza e praticità: angolari o rettangolari, di diverse dimensioni, in ottone cromato.

*Practical racks to hold objects and shower hooks, that are both elegant and practical: designed to be mounted in the corner or rectangular, in various sizes, made from chrome-plated brass and ABS.*

---



**50001**



**50002**



**50003**



**50011**



**50012**



**50013**



**50021**



**50022**



**50030**



**50031**



**50032**

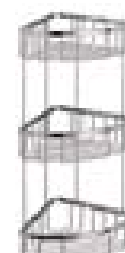

**50033**



**50038**

---

Griglia doccia angolare /  
*Corner basket for shower*

- 50001** L 198 x H 70 x P 160 mm  
**50002** L 250 x H 70 x P 198 mm  
**50003** L 297 x H 70 x P 238 mm
- 

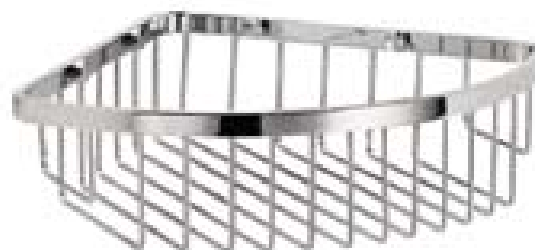

---

Griglia doccia angolare /  
*Corner basket for shower*

- 50011** L 245 x H 60 x P 150 mm  
**50012** L 325 x H 60 x P 190 mm
- 

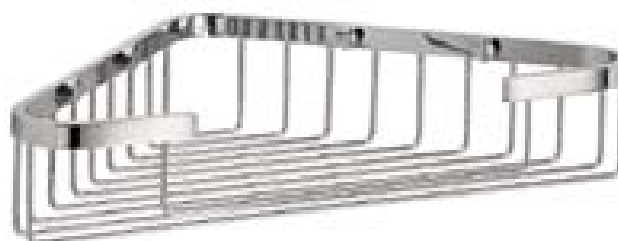

- 
- 50013** Griglia doccia angolare /  
*Corner basket for shower*  
L 205 x H 85 x P 260 mm
- 

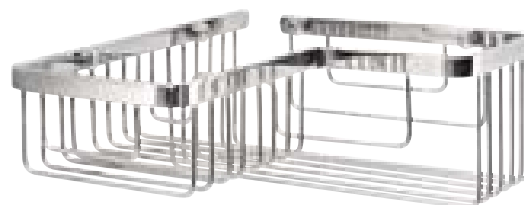

---

Portaoggetti da doccia /  
*Basket for shower*

- 50021** L 290 x H 55 x P 140 mm  
**50022** L 400 x H 60 x P 140 mm
- 

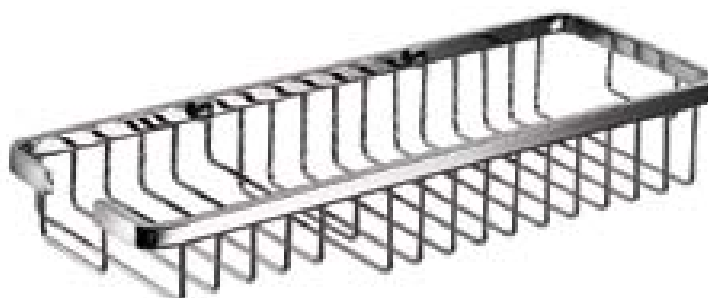

---

**50030** Griglia doccia doppia, da appendere /  
*Hanging double shelf basket for shower*  
L 300 x H 680 x P 210 mm

---



---

**50031** Griglia doccia doppia, da appendere /  
*Hanging double shelf basket for shower*  
L 250 x H 550 x P 220 mm

---



---

**50032** Griglia doccia angolare doppia /  
*Double shelf corner basket for shower*  
L 270 x H 290 x P 205 mm

---



---

**50033** Griglia doccia angolare tripla /  
*Triple shelf corner basket for shower*  
L 270 x H 510 x P 205 mm

---



---

**50038** Appendini per termoarredo (12 pezzi  
assortiti in 4 colori) /  
*Hooks for radiators (12 pieces,  
set of 4 colours)*  
L 40 x H 140 x P 60 mm

---



---

# SUPIONI

---

Avvolgenti getti di benessere dalla collezione di grandi soffioni per doccia in ottone cromato o mattstone, tondi o quadrati, autopulenti e dotati di riduttori di portata.

*Enveloping jets of wellness from the collection of large shower heads in chrome-plated brass or mattstone, round or square, self-cleaning and equipped with flow restrictors.*

---



53801 - 53802

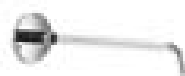

53802 R



53804 - 53805



53806 - 53807



53807R

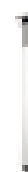

53808 - 53809



53810 - 53811  
53812



53815 - 53816  
53817



53818



53819



53820



53825



53826



53829

Braccio doccia tondo a parete per snodo 1/2" /  
*Wall round shower-arm, 1/2" connection*

**53801** L 62 x H 100 x P 320 mm

**53802** L 62 x H 100 x P 420 mm



**53802R** Rinforzo per braccio tondo /  
*Round sure grip shower-arm flange*

Ø 120 x P 63 mm



Braccio doccia a soffitto, tondo, per snodo 1/2" /  
*Ceiling round shower-arm, 1/2" connection*

**53804** Ø 62 x P 250 mm

**53805** Ø 62 x P 490 mm

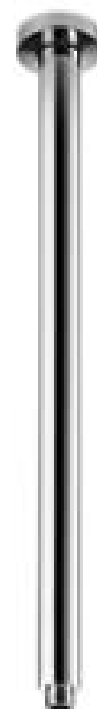

---

Braccio doccia a parete, quadro, per snodo 1/2" /  
*Wall square shower-arm, 1/2" connection*

**53806** L 55 x H 55 x P 320 mm

**53807** L 55 x H 55 x P 420 mm

---



---

**53807R** Rinforzo per braccio quadro /  
*Square sure grip shower-arm flange*

L 100 x H 100 x P 63 mm

---

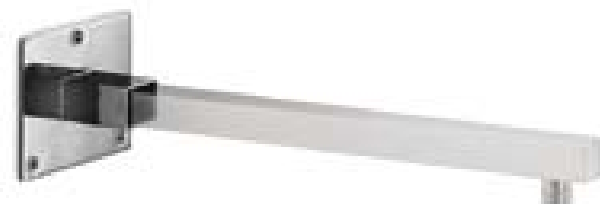

---

Braccio doccia a soffitto, quadro, per snodo 1/2" /  
*Ceiling square shower-arm, 1/2" connection*

**53808** L 55 x H 55 x P 250 mm

**53809** L 55 x H 55 x P 490 mm

---

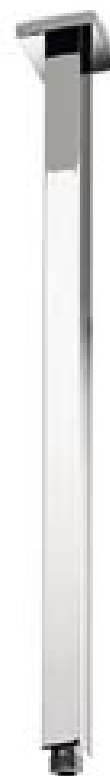

---

Soffione doccia autopulente, con snodo 1/2" /  
*Self-cleaning shower head, with 1/2" connection*

**53810** Ø 180 x H 69 mm

**53811** Ø 230 x H 69 mm

**53812** Ø 300 x H 69 mm

---





Soffione doccia autopulente, con snodo 1/2" /  
*Self-cleaning shower head, with 1/2" connection*

**53815** L 180 x H 69 x P 180 mm

**53816** L 230 x H 69 x P 230 mm

**53817** L 300 x H 69 x P 300 mm



**53818** Soffione doccia autopulente, con snodo 1/2" /  
*Self-cleaning shower head, with 1/2" connection*

L 230 x H 69 x P 160 mm



**53819** Soffione doccia autopulente, con snodo 1/2" /  
*Self-cleaning shower head, with 1/2" connection*

L 250 x H 69 x P 180 mm



**53820** Soffione doccia autopulente a parete, con snodo 1/2" /  
*Orientable, self-cleaning wall shower head, with 1/2" connection*

L 100 x H 135 x P 200 mm



---

**53825** Soffione doccia autopulente, con snodo ½" /  
*Self-cleaning shower head, with ½" connection*  
Ø 275 x 55 mm

---



---

**53826** Soffione doccia autopulente, con snodo ½" /  
*Self-cleaning shower head, with ½" connection*  
L 275 x H 55 x P 275 mm

---





---

**53829** Doccia da esterno, con miscelatore e rubinetto lavapiedi  
in acciaio inox /  
*Outdoor shower with stainless steel mixing device and foot  
washer*

L 400 x H 2200 x P 620 mm

---

---

# LINEA DOCCIA

---

Aste saliscendi, colonne per doccia in ottone cromato, attrezzabili liberamente con flessibili e doccette. Linea completata ed arricchita dalla presenza di oggetti per ripararsi dagli spruzzi della doccia: tenda in cotone waterproof, ganci e barre in ottone cromato.

*Chrome-plated brass shower head riser rails, shower columns that can be freely equipped with flexible tubes and hand-held shower heads. The line is completed and enriched by the selection of objects designed to protect you from the shower spray: waterproof cotton curtain, chrome-plated brass hooks and bars.*

---

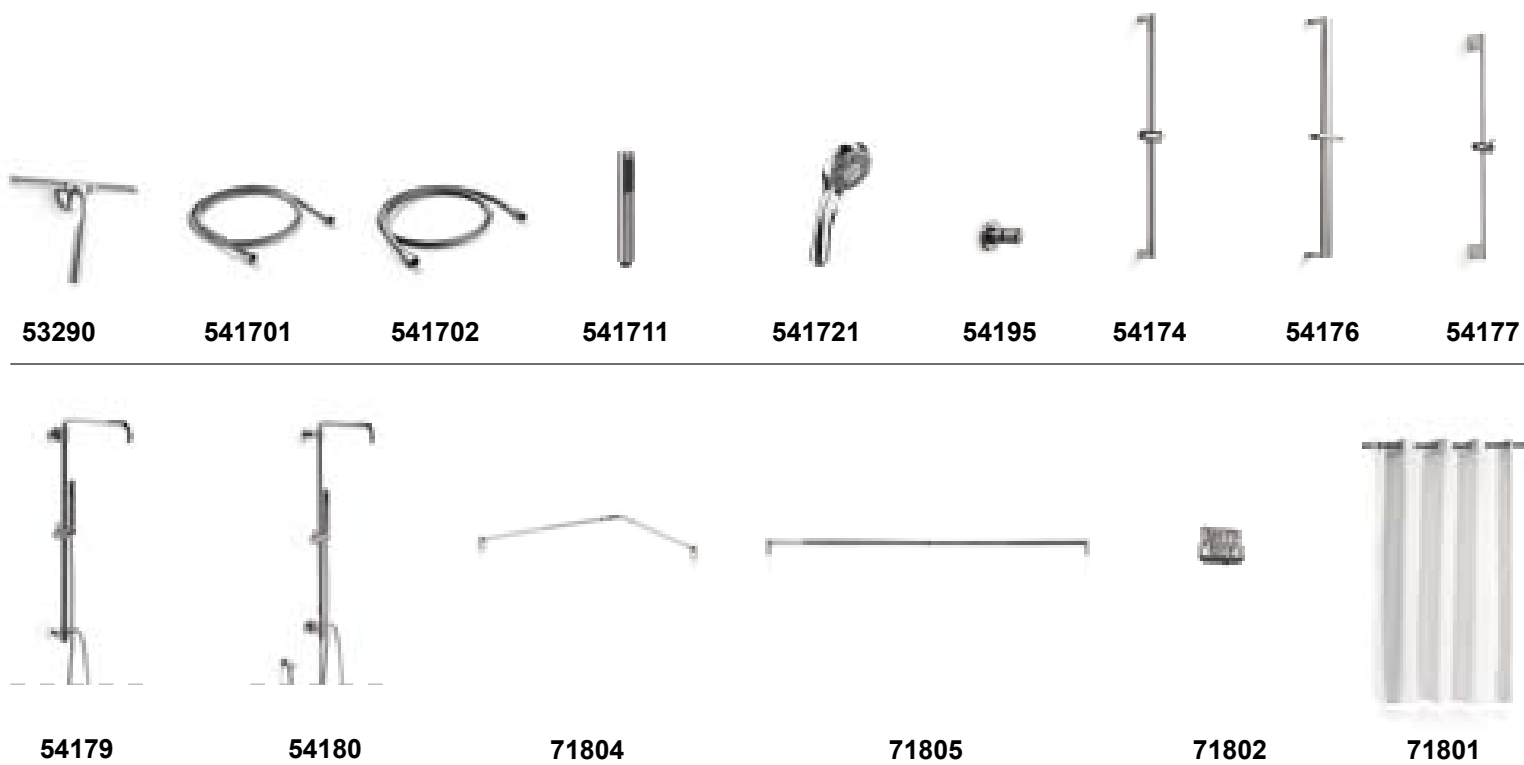

---

**53290** Puliscivetri /  
*Bathroom glasses wiper*  
L 220 x H 165 x P 45 mm

---



---

**541701** Flessibile doppia maglia 1500 mm,  
con attacco conico da 1/2" /  
*Double seam flexible hose 1500 mm,  
with 1/2" connection*  
L 1500

---



---

**541702** Flessibile PVC 1500 mm, con attacco  
conico da 1/2" /  
*PVC flexible hose 1500 mm, with 1/2"  
connection*  
L 1500

---



---

**541711** Doccetta cilindrica anticalcare /  
*Hand shower, with antilimestone jet*  
Ø 28 x H 185 mm

---

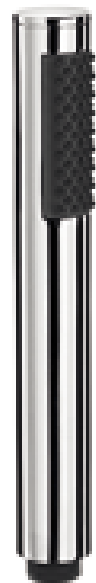

---

**541721** Doccetta anticalcare, 3 getti regolabili /  
*Antilimestone hand shower with 3 jets*  
L 100 x H 220 mm

---



---

**54195** Soffione laterale orientabile /  
*Lateral orientable shower head*  
Ø 25 x P 66 mm

---



---

**54174** Asta saliscendi tubo tondo /  
*Round sliding rail*  
L 100 x H 840 x P 60 mm

---

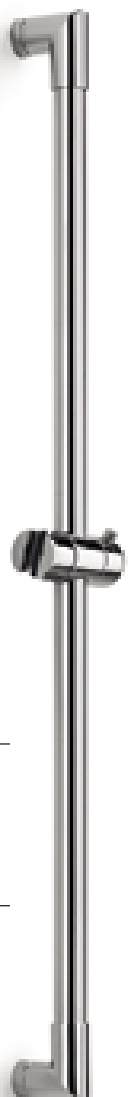

---

**54176** Asta saliscendi tubo rettangolare /  
*Square sliding rail*  
L 140 x H 807 x P 75 mm

---



---

**54177** Asta saliscendi /  
*Sliding rail*  
L 100 x H 820 x P 65 mm

---

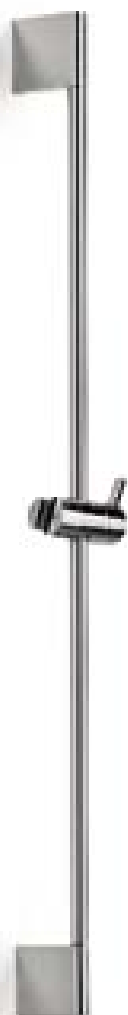



---

**54179** Colonna doccia con presa d'acqua diretta, con deviatore, flessibile, doccetta cilindrica, altezza regolabile /  
*Equipped shower column, taking water direct from the wall, with diverter and hose, antilimestone hand shower, adjustable height*

L 100 x H min 1200 - max 1400 x P 425 mm

---



---

**54180** Colonna doccia con deviatore, flessibili, doccetta cilindrica, altezza regolabile /  
*Equipped shower column with diverter and hose, antilimestone hand shower, adjustable height*

L 100 x H 1200 - max 1400 x P 425 mm

---



---

**71804** Tubo per doccia ad angolo, accorciabile /  
*Shortened corner shower curtain holder*  
L 1007 x H 80 x P 1007 mm

---



---

**71805** Tubo per doccia dritto, accorciabile /  
*Shortened straight shower curtain holder*  
L 1770 x H 80 x Ø 25 mm

---



---

**71802** Set 12 ganci tenda /  
*12 shower curtain hooks*  
L 40 x H 68 mm

---



---

**71801** Tenda doccia in cotone waterproof /  
*Waterproof cotton shower curtain*  
L 1800 x H 2000 mm

---



---

# ATLANTICA

---

Completano la sezione doccia una serie di pedane indoor e outdoor, squadrate o angolari, realizzate in pregiato multistrato marino.

*A series of indoor and outdoor floor stands complete the shower section, square or angular, made from high quality marine plywood.*

---



Pedana doccia in multistrato marino di Okumè /  
*Marine Okoume plywood shower mat*

<b>7224.08</b>	L 500 x H 20 x P 500 mm
<b>7225.08</b>	L 540 x H 20 x P 540 mm
<b>7226.08</b>	L 600 x H 20 x P 600 mm
<b>7227.08</b>	L 640 x H 20 x P 640 mm
<b>72271.08</b>	L 750 x H 20 x P 750 mm
<b>7228.08</b>	L 740 x H 20 x P 540 mm
<b>7229.08</b>	L 1000 x H 20 x P 600 mm



Pedana doccia in multistrato marino di Okumè /  
*Marine Okoume plywood shower mat*

<b>7230.08</b>	L 640 x H 20 x P 640 mm
<b>7231.08</b>	L 740 x H 20 x P 740 mm
<b>7232DX.08</b>	L 720 x H 20 x P 510 mm
<b>7232SX.08</b>	L 720 x H 20 x P 510 mm



4071 SAON / 53559 MOMON / 54231-5540 MUCI / 8040-8050-8060 CIACOLE /

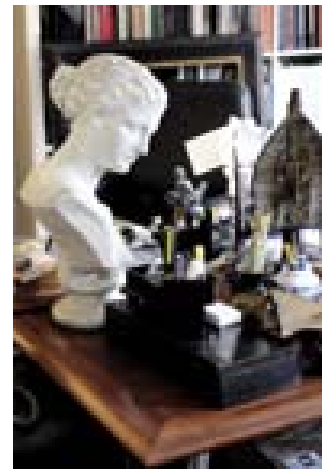

studio rocchi & associati | architects | verona | italy

---

CONTENITORI & MOBILI / *CABINETS & FURNITURE*

---

<b>RUNNER</b>	basi acciaio inox / <i>stainless steel units</i>	<b>224</b>	PRICELIST 143
<b>PIKÀ</b>	pensili con specchio / <i>mirrored cabinets</i>	<b>228</b>	PRICELIST 146
<b>BEJ</b>	contenitori legno / <i>plywood cabinets</i>	<b>234</b>	PRICELIST 150
<b>CIACOLE</b>	contenitori alluminio / <i>aluminum cabinets</i>	<b>240</b>	PRICELIST 153
<b>CANAVERA</b>	mobili bambù / <i>bamboo furniture collection</i>	<b>250</b>	PRICELIST 156

---

# RUNNER

---

Linea di mobili contenitori dalle linee semplici ed essenziali, realizzati in inox lucido e dotati di ruote, per agevolarne lo spostamento ed aumentarne la funzionalità. La linea presenta modelli con cassetti, e ante.

*A line of cabinets with simple and basic lines, made from polished stainless steel and fitted with wheels, to make them easier to move them, making them even more functional. The line offers models with drawers, and doors.*

---

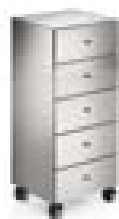

5430



5431



5433



5435



5436



5437



5438



5439  
5440 - 5441



---

**5430** Base 5 cassetti con ruote /  
*5 drawers unit on wheels*  
L 350 x H 800 x P 320 mm

---



---

**5431** Base 2 cassetti, 1 anta, con ruote /  
*1 door, 2 drawers unit on wheels*  
L 350 x H 800 x P 320 mm

---

Disponibile apertura SX e DX /  
*Available SX and DX opening*

---



---

**5433** Base 2 ante, con ruote /  
*2 doors unit on wheels*  
L 600 x H 660 x P 320 mm

---



---

**5435** Base 1 cassetto, 1 anta, con ruote /  
*1 door, 1 drawer unit on wheels*  
L 350 x H 800 x P 320 mm

---

Disponibile apertura SX e DX /  
*Available SX and DX opening*

---



---

**5436** Base 3 cassetti, con ruote /  
*3 drawers unit, on wheels*  
L 350 x H 510 x P 420 mm

---



---

**5437** Base 1 anta, con ruote /  
*1 door unit on wheels*  
L 350 x H 510 x P 420 mm

---

Disponibile apertura SX e DX /  
*Available SX and DX opening*

---



---

**5438** Base 2 cassetti, con ruote /  
*2 drawers unit, on wheels*  
L 350 x H 510 x P 420 mm

---



---

Copribase vetro /  
*Glass TOP*

**5439** L 350 x H 9 x P 300 mm

**5440** L 400 x H 9 x P 350 mm

**5441** L 600 x H 9 x P 300 mm

---



---

# PIKÀ

---

Serie di pensili a muro e rotanti, dal design funzionale, realizzati in acciaio inox lucido con ripiani interni in vetro temperato.

*A series of wall-mounted and rotating cabinets, with a practical design, made from polished stainless steel and containing tempered glass shelves.*

---

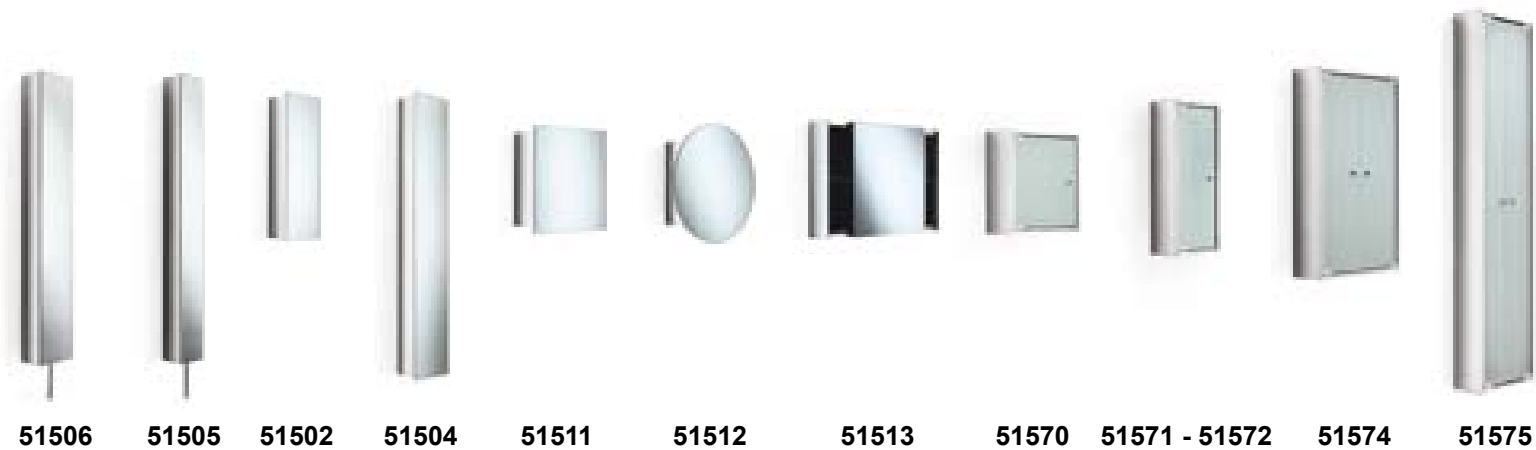



---

**51506** Pensile girevole con specchio /  
*Swivel cabinet with mirror*

L 250 x H 1830 x P 265 mm

---



---

**51505** Pensile girevole con specchio /  
*Swivel cabinet with mirror*

L 160 x H 1830 x P 235 mm

---



---

Pensile con specchio /  
*Cabinet with mirror*

**51502** L 280 x H 830 x P 155 mm

**51504** L 280 x H 1630 x P 155 mm

---

---

**51511**    Pensile con specchio /  
*Cabinet with mirror*  
L 450 x H 450 x P 150 mm

---



---

**51512**    Pensile con specchio /  
*Cabinet with mirror*  
Ø 590 x P 150 mm

---



---

**51513**    Pensile con specchio, con cassetti laterali /  
*Mirrored cabinet with sliding drawers*  
L 590 x H 590 x P 160 mm

---



---

**51570** Pensile con 1 anta /  
*Cabinet with 1 door*  
L 400 x H 400 x P 140 mm

---



---

Pensile con 1 anta /  
*Cabinet with 1 door*  
**51571** L 250 x H 600 x P 140 mm  
**51572** L 250 x H 800 x P 140 mm

---







---

Pensile con 2 ante /  
*2 doors cabinet*

**51574** L 465 x H 800 x P 140 mm

**51575** L 300 x H 1400 x P 140 mm

---



---

# BEJ

---

Colorati, divertenti e pratici, una perfetta soluzione salvaspazio per arredare il bagno e non solo. Mobili realizzati in multistrato impiallacciato bianco e pannello posteriore in acciaio inox laccato gofrato, con ante a specchio.

*Colourful, fun and practical, a perfect space-saving solution to furnish bathrooms and more. Cabinets made from white veneered plywood and rear panel in embossed lacquered stainless steel, with mirror doors.*

---



8010



8015



8016



8020



8030

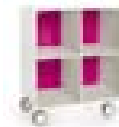

8031

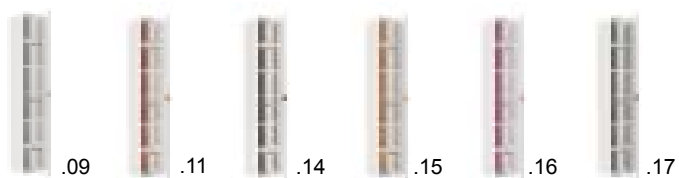

---

**8010** Pensile con anta a specchio /  
*Cabinet with mirror door*

L 190 x H 1610 x P 206 mm

---

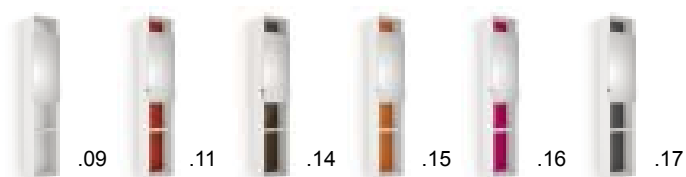

---

**8015** Pensile con anta a specchio /  
*Cabinet with mirror door*

L 310 x H 1600 x P 206 mm

---



**8020** Pensile con anta a specchio /  
*Cabinet with mirror door*  
 L 305 x H 810 x P 206 mm

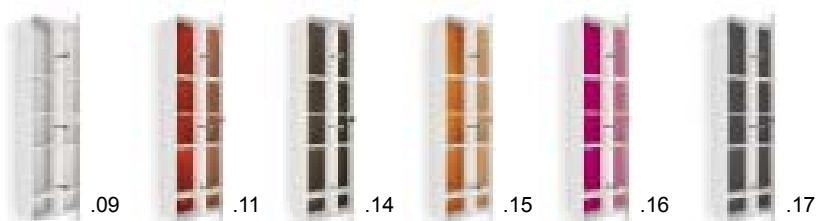

**8016** Pensile con anta a specchio /  
*Cabinet with mirror door*  
 L 305 x H 1610 x P 206 mm

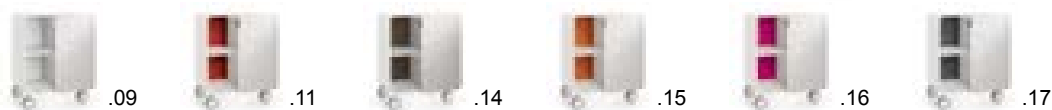

**8030** Base con anta a specchio, su ruote /  
*Mirror door unit, on wheels*  
L 605 x H 710 x P 406 mm

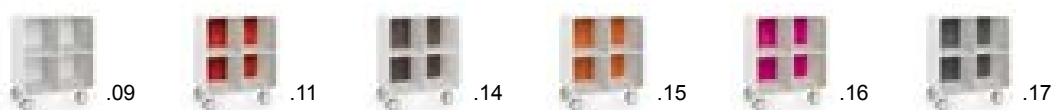

**8031** Base a giorno, su ruote /  
*Unit, on wheels*  
L 600 x H 710 x P 400 mm



SEX



# Exhibitionism



---

# CIACOLE

---

Una linea determinata dall'idea di bagno flessibile, comodo, funzionale e coloratissimo. Sistema di contenitori a colonna, aperti o con battente a specchio, da fissare a parete o girevoli, realizzati in alluminio e mattstone.

*A line based on the idea of a bathroom that is flexible comfortable, functional and very colourful. A system of containers arranged in a column, either open or with mirror doors, to be wall-mounted or rotating, made from aluminum and mattstone.*

---

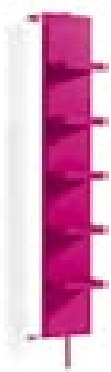

8040



8058



8050



8054



8060 + 8061



8062

---



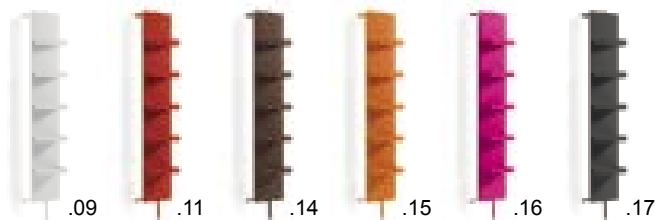
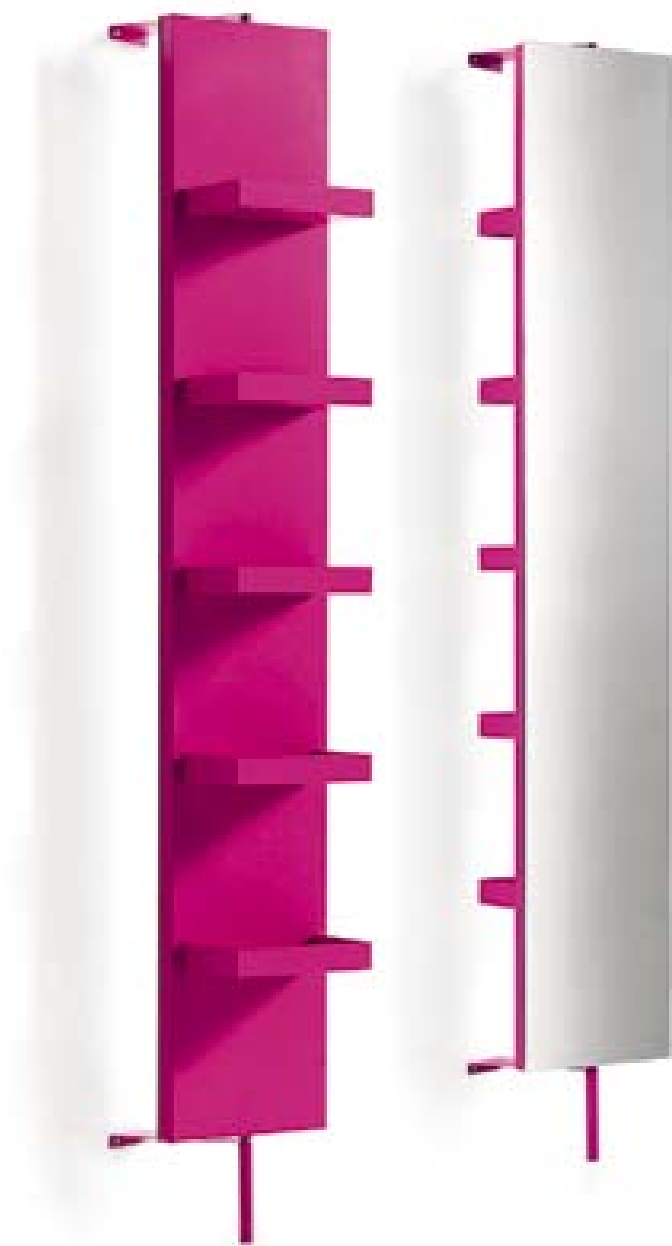

---

**8040**    Pensile girevole con specchio /  
*Swivel cabinet with mirror*  
L 280 x H 1790 x P 370 mm

---

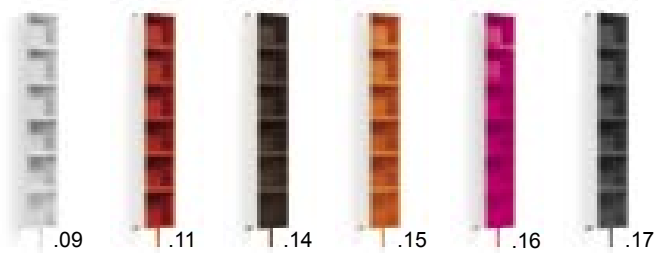

**8058** Pensile girevole con specchio, fianchi in mattstone /  
*Swivel cabinet with mirror, mattstone sides panelled*  
L 265 x H 1760 x P 235 mm



**8050** Pensile con anta a specchio, fianchi in mattstone /  
*Cabinet with mirror door, mattstone sides panelled*  
 L 265 x H 800 x P 165 mm

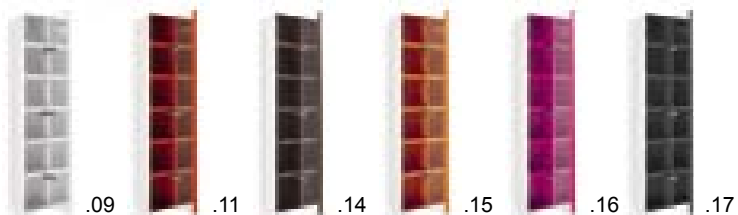

**8054** Pensile con anta a specchio, fianchi in mattstone /  
*Cabinet with mirror door, mattstone sides panelled*  
 L 265 x H 1590 x P 165 mm



---

**8040** Pensile girevole con specchio /  
*Swivel cabinet with mirror*  
L 280 x H 1790 x P 370 mm

---



**8040**

Pensile girevole con specchio /  
*Swivel cabinet with mirror*

L 280 x H 1790 x P 370 mm

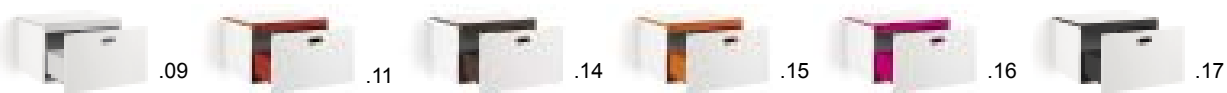

Base 1 cassetto, rivestita in mattstone /  
*1 drawer unit, mattstone panelled*

**8060** L 500 x H 330 x P 420 mm

**8061** L 700 x H 330 x P 420 mm

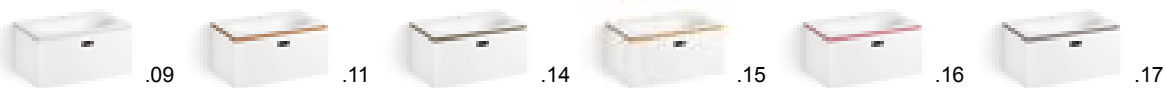

---

**8062**

Base 1 cassetto, rivestita in mattstone, con piano  
lavabo termoformato in resina acrilica /  
*1 door unit, mattstone panelled, in acrylic resin  
thermoformed washbasin*

L 700 x H 330 x P 420 mm

---



---

**8058** Pensile girevole con specchio, fianchi in mattstone /  
*Swivel cabinet with mirror, mattstone sides panelled*  
L 265 x H 1760 x P 235 mm

---





---

# CANAVERA

---

Mobili in 100% bambù, verniciati ad acqua, per coniugare perfettamente qualità e rispetto dell'ambiente, impeccabile combinazione eco-friendly.

*100% bamboo cabinets, with water-based paint, for the perfect combination of quality and respect for the environment, an impeccable eco-friendly combination.*

---



81107



81110



81113



81121



81122

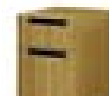

81123



81124



81129



81154



81155



81167



81169



811219 - 811549  
811559 - 811679 - 811699



811600

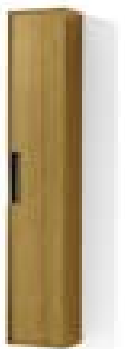

81130



81141

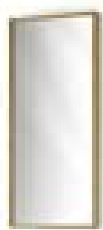

81140

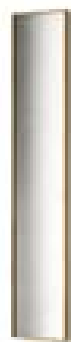

81149

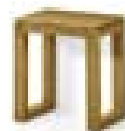

81119



81120



---

**81107** Supporto per lavabo, in bambù /  
*Bamboo solid wood wash-table unit*  
L 700 x H 760 x P 460 mm

---



---

**81110** Supporto per lavabo, in bambù /  
*Bamboo solid wood wash-table unit*  
L 1000 x H 760 x P 460 mm

---



---

**81113** Supporto per lavabo, in bambù /  
*Bamboo solid wood wash-table unit*  
L 1300 x H 760 x P 460 mm

---



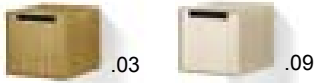

---

**81121** Base con 1 cassetto, in bambù /  
*Bamboo solid wood unit, with 1 drawer*  
L 400 x H 382 x P 460 mm

---

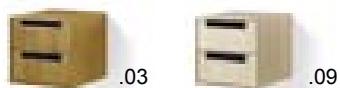

---

**81122** Base con 2 cassetti, in bambù /  
*Bamboo solid wood unit, with 2 drawers*  
L 400 x H 382 x P 460 mm

---



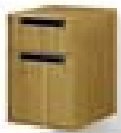

.03



.09

**81123**

Base con 2 cassetti, in bambù /  
*Bamboo solid wood unit, with 2 drawers*

L 400 x H 564 x P 460 mm



.03

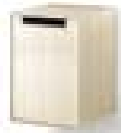

.09

**81124**

Base in bambù, con 1 anta e ripiano interno in vetro /  
*Bamboo solid wood unit, with 1 door and glass shelf*

L 400 x H 564 x P 460 mm

Disponibile apertura SX e DX /  
*Available SX and DX opening*



**81129**

Set 4 piedini in ottone cromato /  
*4 feet set chromed brass*

L 40 x H 100 x P 62 mm





.03

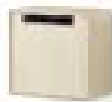

.09

**81154** Base supporto lavabo con 1 anta in bambù /  
*Bamboo solid wood washbasin unit, with 1 door*

L 400 x H 382 x P 260 mm

Disponibile apertura SX e DX /  
*Available SX and DX opening*

Abbinabile con lavabo mattstone Art. 53557.26  
e sifone Art. 53927.29 /  
*Matching with mattstone washbasin Art. 53557.26  
and siphon Art. 53927.29*



.03



.09

**81155** Base supporto lavabo con 1 cassetto in bambù /  
*Bamboo solid wood washbasin unit, with 1 drawer*

L 500 x H 382 x P 460 mm

Abbinabile con sifone Art. 53921 /  
*Matching with siphon Art. 53921*



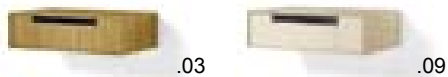

Base supporto lavabo con 1 cassetto in bambù /  
*Bamboo solid wood washbasin unit, with 1 drawer*

**81167** L 700 x H 200 x P 460 mm

**81169** L 900 x H 200 x P 460 mm

Abbinabile con sifone Art. 53921 /  
*Matching with siphon Art. 53921*



TOP in bambù /  
*TOP in bamboo solid wood*

**811219** L 460 x H 18 x P 400 mm

**811549** L 400 x H 18 x P 260 mm

**811559** L 500 x H 18 x P 460 mm

**811679** L 700 x H 18 x P 460 mm

**811699** L 900 x H 18 x P 460 mm



**811600** TOP in mattstone su misura, lunghezza massima  
 1800 x 460 mm /  
*Mattstone bespoke TOP, maximum length  
 1800 x 460 mm*







---

**81130** Pensile in bambù, con ripiani in vetro /  
*Bamboo solid wood cabinet, with glass shelves*  
 L 300 x H 1600 x P 200 mm

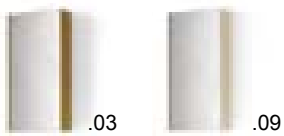
---





---

**81141** Specchio contenitore in bambù,  
 con ripiani in vetro /  
*Container mirror in bamboo solid wood,  
 with glass shelves*  
 L 400 x H 800 x P 150 mm

---

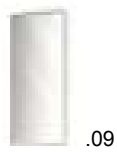
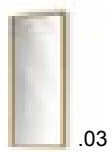



---

**81140** Specchio con cornice in bambù, verticale o orizzontale /  
*Mirror vertical or horizontal, with frame in bamboo solid wood*

L 400 x H 900 x P 42 mm

---

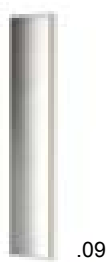

---

**81149** Specchio con cornice in bambù, verticale o orizzontale /  
*Mirror vertical or horizontal, with frame in bamboo solid wood*

L 300 x H 1650 x P 42 mm

---



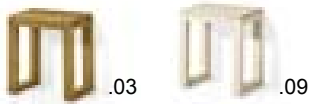

---

**81119** Sgabello in bambù /  
*Bamboo solid wood stool*  
L 400 x H 450 x P 290 mm

---



---

**81120** Panca in bambù /  
*Bamboo solid wood bench*  
L 1100 x H 450 x P 360 mm

---











52816 SKUARA / 53559 MOMON / 54231 MUCI / 57016 CIARI / 81123-811600 CANAVERA /



53716 ACQUAIO / 53922 BUSI & CANE / 54234 MUCI / 5592 MEVEDO / 5632 SPECI / 81113-81123-81129 CANAVERA /



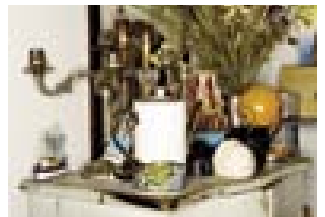
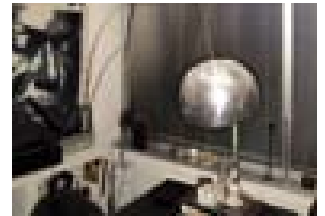

enrico 'kali' dalle carbonare's home | graphic & dj | schio | italy

---

SPECCHI & LAMPADE / *MIRRORS & LAMPS*

---

<b>SPECI</b>	<i>specchi / mirrors</i>	<b>268</b>	<u>PRICELIST 165</u>
<b>MEVEDO</b>	<i>ingranditori / magnifying mirrors</i>	<b>280</b>	<u>PRICELIST 175</u>
<b>CIARI</b>	<i>lampade / light fixtures</i>	<b>286</b>	<u>PRICELIST 179</u>

---

# SPECI

---

Collezione di specchi a parete o a fissaggio a piano dalla linea essenziale, dalla forma tonda, ovale, rettangolare o quadrata. Disponibili accoppiati a mensole in cristallo satinato e temperato, a sistema luminoso integrato con accensione e spegnimento touch-screen o con ingranditori.

*A collection of wall-mounted or counter-mounted mirrors with a basic line, round, oval, rectangular or square shape. Available in a shelf-mounted version in frosted and tempered crystal, with a built-in lighting system with touch screen on/off switch or with magnifiers.*

---



**5621 - 5623**



**5631**

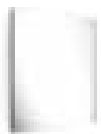

**5633**



**5666 - 5667**



**5632**



**5652**



**5653 - 5655**



**5656**



**5660 - 5661**



**5662 - 5663**



**5664 - 5665**



**56683**



**56703**

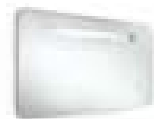

**56704**



**56685**

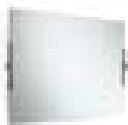

**56686**



**56688**

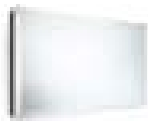

**56689**



**5673 - 5676**



**5685 - 5686**



**5680 - 5681**



**5682**

---

Specchio con telaio inox, con mensola /  
*Mirror with stainless steel frame, with shelf*

**5621** L 595 x H min 720 - max 850 x P 150

**5623** L 595 x H min 610 - max 750 x P 150

---



---

**5631** Specchio con telaio inox /  
*Mirror with stainless steel frame*

L 500 x H 700 x P 40 mm

---

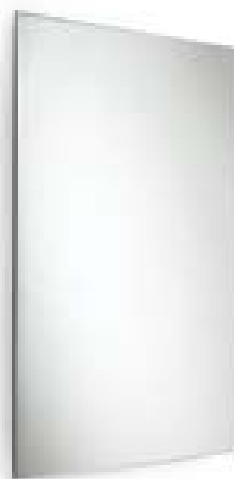

---

**5633** Specchio con telaio inox /  
*Mirror with stainless steel frame*

L 590 x H 590 x P 40 mm

---



---

Specchio molato con ingranditore /  
*Bevelled mirror included of magnifying mirror*

**5666** L 900 x H 440 x P 40 mm

**5667** L 1000 x H 440 x P 40 mm

---



---

**5632** Specchio con telaio inox /  
*Mirror with stainless steel frame*

Ø 590 x P 40 mm

---



---

**5652** Specchio con telaio inox /  
*Mirror with stainless steel frame*

L 440 x H 1000 x P 40 mm

---



---

Specchio con telaio inox /  
*Mirror with stainless steel frame*

**5653** L 320 x H 1000 x P 40 mm

**5655** L 440 x H 1000 x P 40 mm

---



---

**5656** Specchio con telaio inox /  
*Mirror with stainless steel frame*

L 1000 x H 440 x P 40 mm

---

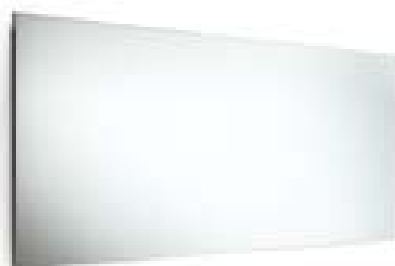



---

Specchio molato /  
*Bevelled mirror*

- 5660** L 600 x H 600 x P 40 mm  
**5661** L 800 x H 600 x P 40 mm
- 



---

Specchio molato /  
*Bevelled mirror*

- 5662** L 1000 x H 600 x P 40 mm  
**5663** L 1300 x H 600 x P 40 mm
- 



---

Specchio molato /  
*Bevelled mirror*

- 5664** L 600 x H 800 x P 40 mm  
**5665** L 600 x H 1000 x P 40 mm
- 



---

**56683** Specchio rotante con fissaggio da piano /  
*Revolving mirror with top fixing*

L 280x H 1074 x P 30 mm

---



---

**56703** Specchio disappannante, con luce integrata, touch screen /  
*Wall mirror with built-in light, demister, touch screen*

L 700 x H 800 x P 55 mm

---

**IP44** 



---

**56704** Specchio disappannante, con luce integrata, touch screen /  
*Wall mirror with built-in light, demister, touch screen*

L 1000 x H 700 x P 55 mm

---

**IP44** 



---

Specchio orientabile /  
*Adjustable mirror*

**56685** L 520 x H 800 x P 55 mm

---



---

Specchio orientabile /  
*Adjustable mirror*

**56686** L 820 x H 500 x P 55 mm

---



---

**56688** Specchio molato /  
*Bevelled mirror*  
L 700 x H 800 x P 29 mm

---



---

**56689** Specchio molato /  
*Bevelled mirror*  
L 1000 x H 600 x P 29 mm

---





Specchio con cornice in alluminio verniciato /  
*Mirror with powder-coated aluminum frame*

**5673** L 325 x H 1000 x P 35 mm

**5676** L 445 x H 1000 x P 35 mm



Specchio, luce LED /  
*Mirror with LED lighting*

**5685** L 700 x H 800 x P 30 mm

**5686** L 700 x H 1000 x P 30 mm

**IP44** 



---

Specchio con cornice in vetro, luce LED /  
*Framed mirror with LED lighting*

**5680** L 400 x H 1000 x P 100 mm

**5681** L 700 x H 1000 x P 100 mm

---

**IP44** **CE**



---

**5682** Specchio con cornice in vetro, luce LED /  
*Framed mirror with LED lighting*

L 700 x H 800 x P 100 mm

---

**IP44** **CE**



---

# MEVEDO

---

Collezione di specchi ingranditori dalla struttura in ottone cromato, disponibili nelle versioni a parete o d'appoggio, con o senza luce a LED.

*A collection of magnifying mirrors with a chrome-plated brass structure, available in wall-mounted or countertop versions, with or without LED light.*

---



5588



5591



5592



5593



5594



5595



5596



55851



55852



55855



55860



55861



55943



55963



---

**5588**    Specchio ingranditore (3X) a parete /  
*Wall magnifying mirror (3X)*  
Ø 186 x H 220 x P min 150 - max 450 mm

---



---

**5591**    Specchio ingranditore (3X) a parete /  
*Wall magnifying mirror (3X)*  
Ø 186 x P 290 mm

---



---

**5592**    Specchio ingranditore (3X) da appoggio /  
*Magnifying table mirror (3X)*  
Ø 186 x H 330 mm

---





---

**5593** Specchio ingranditore (3X) da appoggio /  
*Magnifying table mirror (3X)*  
L 156 x H 300 x P 115 mm

---



---

**5594** Specchio ingranditore (3X) da appoggio /  
*Magnifying table mirror (3X)*  
L 126 x H 326 x P 115 mm

---



---

**5595** Specchio ingranditore (3X) a parete /  
*Wall magnifying mirror (3X)*  
L 156 x H 206 x P 120 mm

---



---

**5596** Specchio ingranditore (3X) a parete /  
*Wall magnifying mirror (3X)*  
L 126 x H 230 x P 125 mm

---



---

**55851** Specchio ingranditore (3X) da appoggio /  
*Magnifying table mirror (3X)*  
L 230 x H 395 x Ø 140 mm

---



---

**55852** Specchio ingranditore (3X) a parete /  
*Wall magnifying mirror (3X)*  
L 290 x H 260 x P min 60 - max 395 mm

---



---

**55855** Specchio ingranditore (3X) a parete /  
*Wall magnifying mirror (3X)*  
L 230 x H 430 x P min 110 max 420 mm

---

---

**55860** Specchio ingranditore (3X) da appoggio  
con luce LED /  
*Magnifying table mirror (3X) with  
LED light*

Ø 230 x H 405 mm

---

**IP44** **CE**



---

**55861** Specchio ingranditore (3X) a parete con  
luce LED /  
*Wall magnifying mirror (3X) with  
LED light*

Ø 230 x P 250 mm

---

**IP44** **CE**



---

**55943** Specchio ingranditore (3X) da appoggio /  
*Magnifying table mirror (3X)*  
Ø 186 x H 315 x P 130 mm

---



---

**55963** Specchio ingranditore (3X) a parete /  
*Wall magnifying mirror (3X)*  
Ø 186 x H 220 x P 120 mm

---



---

# CIARI

---

Collezione di lampade a LED, ad alta efficienza luminosa e alogene. Con certificazione IP44, a muro o a specchio, in ottone cromato o verniciato.

*A collection of LED lamps, with high efficiency and halogen lighting. With IP44 certification, wall or mirror mounted, in chrome-plated or painted brass.*

---



**57014**



**57016**



**57013**



**57018**



**57019**



**57021**



**57022**



**57023**



**57024**



**57030 - 57031**



**5707**



**5720**



**5721**



**5722**



**5723**



**5724**



---

**57014** Lampada a LED da parete in vetro /  
*Glass wall LED lamp*  
L 320 x H 77 x P 56 mm

---

**IP44**  

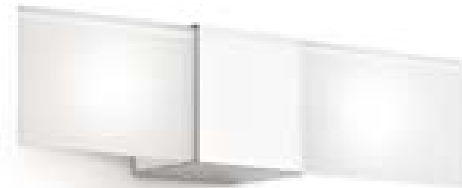

---

**57016** Lampada a LED da parete in vetro /  
*Glass wall LED lamp*  
L 77 x H 75 x P 153 mm

---

**IP44**  





---

**57013** Lampada a LED da parete con specchio /  
*Glass wall LED lamp with mirror*  
L 320 x H 80 x P 56 mm

---

**IP44** CE □



---

**57018** Lampada alogena a parete /  
*Wall halogen lamp*  
L 185 x H 90 x P 117 mm

---

**IP44** CE □



---

**57019** Lampada alogena a specchio /  
*Halogen lamp to fix on mirror*  
L 185 x H 160 x P 110 mm

---

**IP44** CE □



---

**57021** Lampada alogena a specchio /  
*Halogen lamp to fix on mirror*  
L 224 x H 205 x P 115 mm

---

**IP44**  



---

**57022** Lampada alogena a specchio /  
*Halogen lamp to fix on mirror*  
L 260 x H 260 x P 200 mm

---

**IP44**  



---

**57023** Lampada LED a specchio /  
*LED lamp to fix on mirror*  
Ø 36 x H 210 x P 100 mm

---

**IP44**  



**57024** Lampada LED a specchio /  
*LED lamp to fix on mirror*  
L 220 x H 205 x P 120 mm

**IP44** CE □



Lampada fluorescente /  
*Wall fluorescent lamp*

**57030** L 600 x H 55 x P 36 mm  
**57031** L 940 x H 55 x P 36 mm

**IP44** CE □

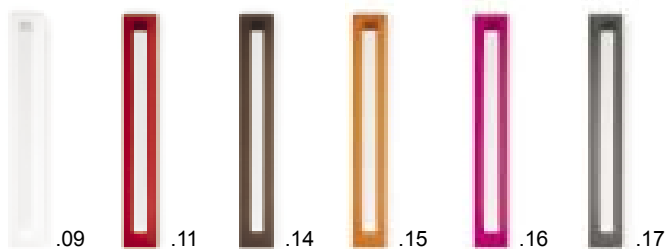

**5707** Plafoniera LED /  
*LED lamp*  
L 700 x H 55 x P 100 mm

**IP44** CE □



---

**5720** Lampada LED a specchio /  
*LED lamp to fix on mirror*

L 30 x H 175 x P 255 mm

---

**IP44** **CE** 



---

**5721** Lampada LED a specchio /  
*LED lamp to fix on mirror*

L 30 x H 70 x P 200 mm

---

**IP44** **CE** 



---

**5722** Lampada LED a specchio /  
*LED lamp to fix on mirror*

L 300 x H 35 x P 110 mm

---

**IP44** **CE** 



---

**5723** Lampada LED a specchio /  
*LED lamp to fix on mirror*  
L 400 x H 130 x P 170 mm

---

**IP44**  



---

**5724** Lampada LED a specchio /  
*LED lamp to fix on mirror*  
L 60 x H 60 x P 111 mm

---

**IP44**  





### CODICE IP (EN 60529) - IP CODE (EN 60529)

Sistema che indica i gradi di protezione di un involucro contro l'accesso a parti pericolose, la penetrazione di corpi solidi, e/o l'ingresso di acqua.  
*A coding system to indicate the degree of protection provided by an enclosure against accessing of solid foreign objects and/or water.*

### PROTEZIONE CONTRO L'INGRESSO DI SOLIDI / PROTECTION AGAINST THE INGRESS OF SOLIDS

IP0X non protetto / *not protected*  
IP1X contro corpi estranei > 50 mm / *against solid foreign objects > 50 mm*  
IP2X contro corpi estranei > 12 mm / *against solid foreign objects > 12 mm*  
IP3X contro corpi estranei > 2,5 mm / *against solid foreign objects > 2,5 mm*  
IP4X contro corpi estranei > 1 mm / *against solid foreign objects > 1 mm*  
IP5X protezione da polvere / *dust protected*  
IP6X stagno alla polvere / *dust-tight*

### PROTEZIONE CONTRO L'INGRESSO DI LIQUIDI / PROTECTION AGAINST THE INGRESS OF LIQUIDS

IPX0 non protetto / *not protected*  
IPX1 contro la caduta vertical di gocce / *against vertically dripping*  
IPX2 contro caduta acqua con inclinazione 15° / *against 15° tilted dripping*  
IPX3 contro la pioggia / *rain protected*  
IPX4 contro gli spruzzi / *splashing protected*  
IPX5 contro i getti acqua / *jetting protected*  
IPX6 contro i getti potenti / *powerful jetting protected*  
IPX7 contro l'immersione temporanea / *against temporary immersion*  
IPX8 contro l'immersione continua / *against continuous immersion*

### CERTIFICAZIONI / CERTIFICATES

TUV Rheinland GS è un certificato fornito dal produttore che attesta l'ammissione in Europa. Dimostrando la totale conformità con GPSG (legge tedesca sulla sicurezza del prodotto) per la Germania, ma anche dimostra la conformità con l'LVD, legge dell' unione europea che assicura che un apparecchio elettrico con certi limiti di voltaggio, offre comunque un alto livello di protezione.

*The TUV Rheinland GS is a certificate presented by manufacturers as the proof for acceptance into Europe. It demonstrates full compliance with the GPSG (German equipment safety law) for Germany; but it also demonstrates compliance to the LVD that ensures that electrical equipment within certain voltage limits provides a high level of protection in the*

### CLASSI DI ISOLAMENTO / CLASS LUMINAIRES

#### CLASSE I

La protezione non si basa unicamente sull'isolamento principale, ma anche su una misura di sicurezza supplementare costituita dalla connessione delle parti conduttrici accessibili ad un conduttore di protezione (messa a terra di protezione) che fa capo all'impianto elettrico fisso, in modo tale che le parti conduttrici accessibili non possano andare in tensione in caso di guasto dell'isolamento principale.

*Provide protection against electrical shock solely using the base insulation and the safe connection of all exposed conductive parts to an earth conductor.*

#### CLASSE II

Gli apparecchi di classe II sono progettati in modo da non richiedere la connessione di messa a terra. Sono costruiti in modo che un singolo guasto non possa causare il contatto con tensioni pericolose da parte dell'utilizzatore. Ciò è ottenuto realizzando l'involucro del contenitore in materiali isolanti, o comunque facendo in modo che le parti in tensione siano circondate da un doppio strato di materiale isolante o usando isolamenti rinforzati.

*Provide protection against electrical shock using both the base insulation and an additional or reinforced insulation. This kind of products do not feature a connection to a protective earth conductor.*

#### CLASSE III

Un apparecchio viene definito di Classe III quando la protezione contro la folgorazione si affida al fatto che non sono presenti tensioni superiori alla Bassissima tensione di sicurezza SELV (Safety Extra-Low Voltage). In pratica tale apparecchio viene alimentato o da una batteria o da un trasformatore SELV.

*Luminaires provide protection against electrical shock by using Safety Extra Low Voltage (SELV). This kind of products are not permitted to generate higher voltages than the Safety Extra Low Voltage.*

### NORMATIVE TECNICHE / NORMATIVE NOTES

Le direttive 89/336/CEE e 73/23/CEE stabiliscono i requisiti essenziali di sicurezza e compatibilità elettromagnetica a cui devono rispondere i materiali elettrici per poter circolare liberamente all'interno del mercato Europeo. Questi requisiti devono essere verificati mediante opportune prove tecniche e la conformità del materiale deve essere indicata mediante l'apposizione del marchio CE sul prodotto o sul suo imballo. La marchiatura è obbligatoria ed il produttore è direttamente responsabile della rispondenza del prodotto ai requisiti essenziali delle direttive sopracitate. La vendita, la commercializzazione e l'acquisto di prodotti privi della marcatura, e quindi non rispondenti alle direttive, è punita a termini di legge.

*The directives 89/336/EEC and 73/23/EEC establish the essential requirements for safety and electromagnetic compatibility that the electric and electronic equipment shall comply for freely circulating in the European market. These requirements must be verified by appropriate tests and compliance of the material must be indicated by the CE marking on the product or its packaging. This marking is mandatory and the producer is directly responsible for product compliance with the essential requirements of the abovementioned Directives. The sale, marketing and purchase of products without the markup, and therefore not meet the guidelines, shall be punished by law.*

## ZONE DI SICUREZZA / SAFETY ZONES

Tutti gli apparecchi elettrici vanno collegati al circuito mantenendo una distanza minima di 0,60 m da lavabi, cabine doccia, vasche e 1,20 m da soffioni doccia.

*Electric appliances must be wired to the electric circuit in a minimum distance of 0,60 m from shower cabins, bath tubs, washbasins and of 1,20 m from shower heads.*

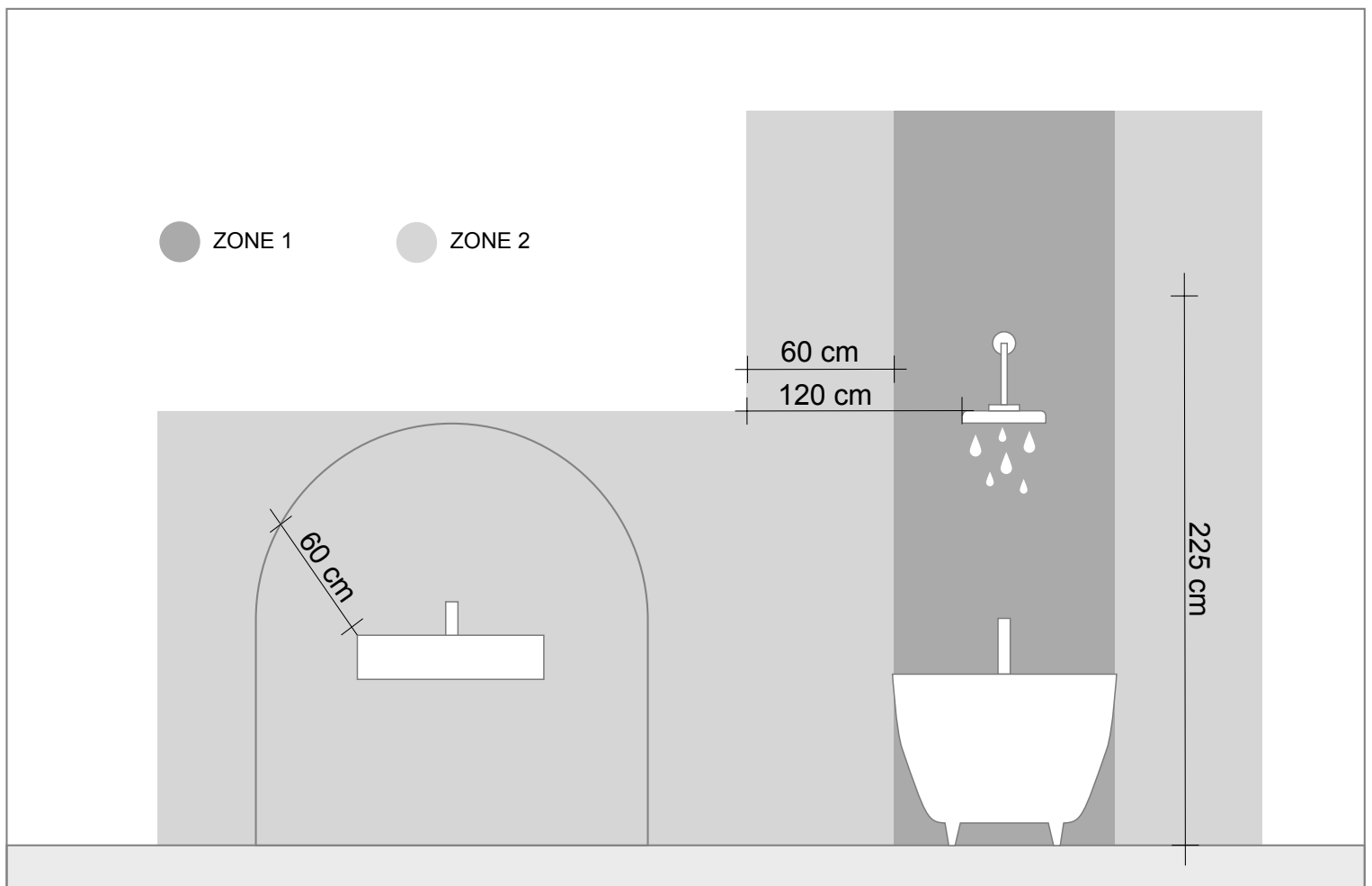



54720 SCAGNI /



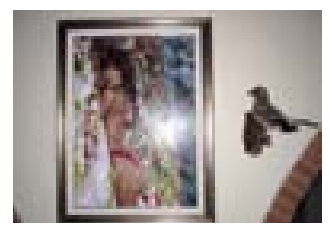
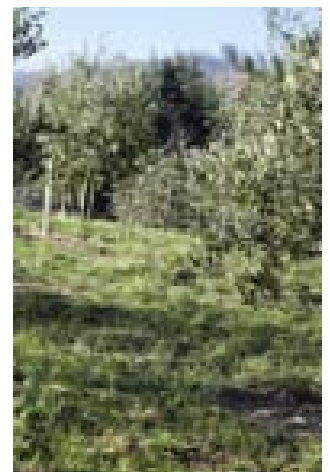

gianluigi marchetto's home | entrepreneur | arzignano | italy

---

COMPLEMENTI / *FURNISHINGS*

---

<b>BASKET</b>	<i>cestini &amp; Co. / paper baskets &amp; Co.</i>	<b>300</b>	PRICELIST 185
<b>SESTI</b>	<i>cesti biancheria / laundry baskets</i>	<b>304</b>	PRICELIST 188
<b>SEZIONI</b>	<i>cesti biancheria / laundry baskets</i>	<b>306</b>	PRICELIST 189
<b>BANDONI</b>	<i>cestini &amp; Co. / paper baskets &amp; Co.</i>	<b>308</b>	PRICELIST 190
<b>SCAGNI</b>	<i>sedute / stools</i>	<b>310</b>	PRICELIST 191
<b>KORAME</b>	<i>accessori ecopelle / ecoleather accessories</i>	<b>312</b>	PRICELIST 193
<b>TAPEI</b>	<i>tappeti / bath mats</i>	<b>314</b>	PRICELIST 194
<b>GHEGHE</b>	<i>linea corpo / body care line</i>	<b>316</b>	PRICELIST 195

---

# BASKET

---

Il metallo è il protagonista di questa collezione di portabiancheria, getta carta e pattumiere dalla forma cilindrica, con o senza coperchio, in acciaio inox lucido quale garanzia di durata.

*Metal is the protagonist of this collection of cylindrical hampers, waste paper baskets and rubbish bins, with or without lids, in polished stainless steel, which is a guarantee it will last a long time.*

---



5344



5347



53297



53298



5345



5348

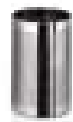

5346



5349

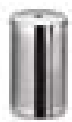

5350

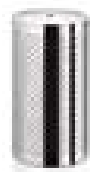

5351

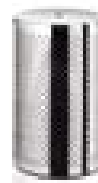

5352

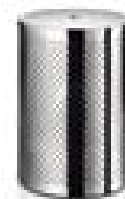

5353

---

Pattumiera /  
*Dustbin*

**5344** 3 Lt - Ø 185 x H 275 x P 220 mm

**5347** 5 Lt - Ø 220 x H 325 x P 250 mm

---



---

Pattumiera /  
*Dustbin*

**53297** 3 Lt - Ø 185 x H 275 x P 265 mm

**53298** 6 Lt - Ø 225 x H 335 x P 305 mm

---



---

Getta carta /  
*Paper basket*

**5345** Ø 200 x H 320 mm

**5348** Ø 250 x H 370 mm

---

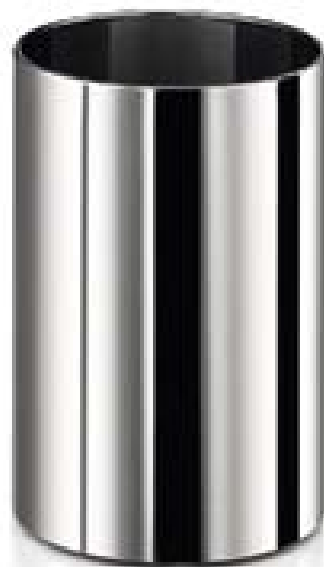

---

Getta carta /  
*Paper basket*

**5346** Ø 200 x H 320 mm

**5349** Ø 250 x H 370 mm

---



---

**5350**    *Getta carta con coperchio /*  
*Paper basket with lid*

Ø 210 x H 320 mm

---

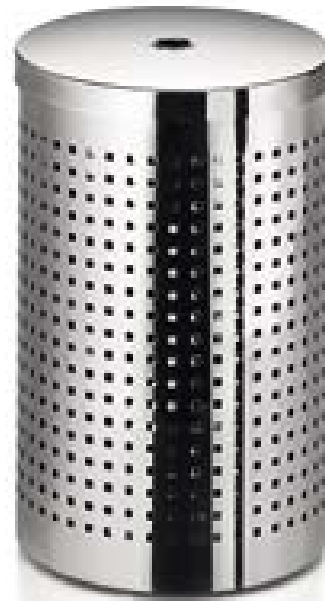

---

*Portabiancheria con coperchio /*  
*Laundry basket with lid*

**5351**    Ø 310 x H 540 mm

**5352**    Ø 365 x H 560 mm

**5353**    Ø 410 x H 570 mm

---

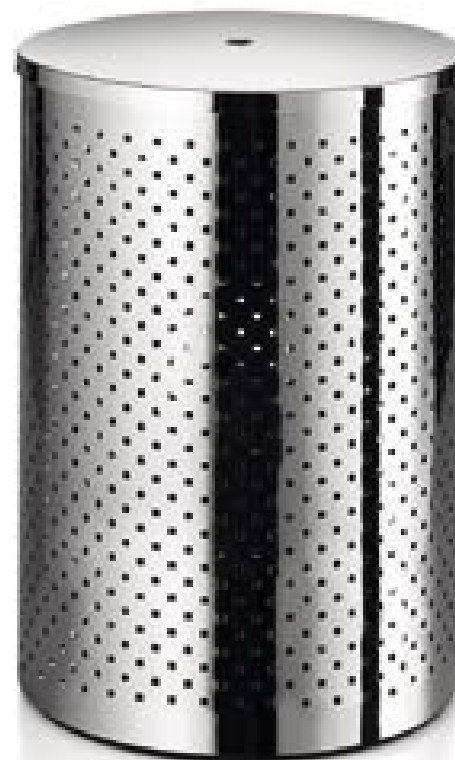

---

# SESTI

---

Fantasia collezione di portabiancheria in metallo brunito traforato, dotati all'interno di un sacco in tela di cotone bianco, Disponibili modelli rettangolari e cilindrici, tutti dotati di coperchio.

*A imaginative collection of burnished perforated metal hampers, lined with a white cotton sack. Available in rectangular and cylindrical models, all equipped with lids.*

---



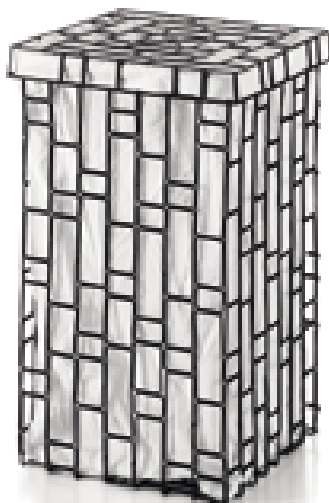

**53309** Portabiancheria con coperchio e sacco in cotone /  
*Laundry basket with cotton bag, with lid*

L 405 x H 670 x P 405 mm

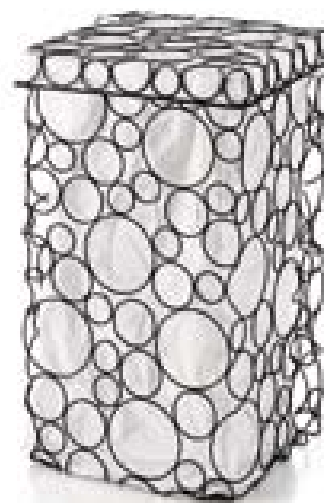

**53310** Portabiancheria con coperchio e sacco in cotone /  
*Laundry basket with cotton bag, with lid*

L 405 x H 670 x P 405 mm



**53311** Portabiancheria con coperchio e sacco in cotone /  
*Laundry basket with cotton bag, with lid*

Ø 430 x H 650 mm



**53312** Portabiancheria con coperchio e sacco in cotone /  
*Laundry basket with cotton bag, with lid*

Ø 430 x H 650 mm

---

# SEZIONI

---

Massimo sfruttamento dello spazio per questi portabiancheria e getta carta dalla forma rettangolare realizzati in acciaio inox lucido. Unico vezzo il coperchio, disponibile in ecopelle bianca o nera.

*These rectangular hampers and waste paper baskets made from polished stainless steel offer the maximum use of space. The only twist is the lid, available in white or black faux-leather.*

---

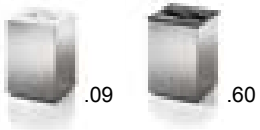

---

**53431** Getta carta con coperchio /  
*Paper basket with lid*  
L 225 x H 330 x P 225 mm

---

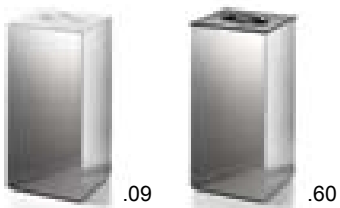

---

Portabiancheria /  
*Laundry basket*  
**53432** L 305 x H 640 x P 305 mm  
**53433** L 405 x H 650 x P 305 mm

---



---

# BANDONI

---

design **JoeVelluto (JVL)**, 2012

Colori vivaci per oggetti decorativi e complementi d'arredo. Getta carta, portabiancheria e porta fazzolettini in alluminio verniciato a polvere.

*Brilliant colours for decorative objects and furnishing accessories. Waste paper basket, hamper and tissue box in powder-coated aluminum.*

---



**53441** Porta salviette /  
*Tissue container*

L 280 x H 90 x P 160 mm

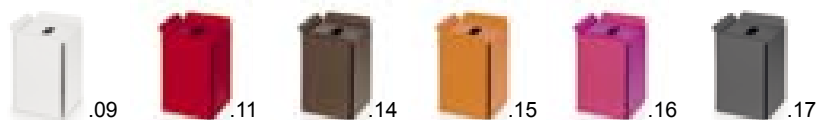

**53442** Gettacarta /  
*Paper basket*

L 220 x H 325 x P 260 mm

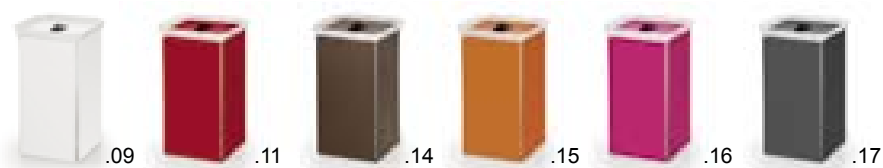

**53443** Portabiancheria /  
*Laundry basket*

L 300 x H 600 x P 350 mm



---

# SCAGNI

---

Collezione di sgabelli dalle forme e materiali eterogenei. Ottone cromato, mattstone bianco, metallo brunito per le versioni da appoggio, teak e acciaio inox insieme per quella ribaltabile.

*A collection of stools of heterogeneous shapes and materials. Chrome-plated brass, white mattstone, burnished metal for the standing versions, teak and stainless steel together for the folding version.*

---



---

**54701** Sgabello /  
*Stool*  
L 400 x H 420 x P 300 mm

---

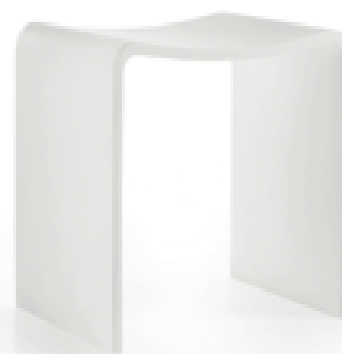

---

**54703** Sgabello /  
*Stool*  
L 400 x H 430 x P 300 mm

---

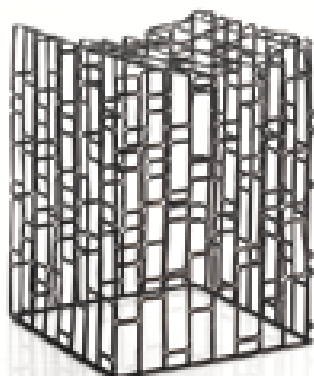

---

**54709** Sgabello /  
*Stool*  
L 330 x H 430 x P 330 mm

---



---

**54710** Sgabello /  
*Stool*  
Ø 330 x H 430 mm

---



---

**54720** Sgabello /  
*Stool*  
L 400 x H 110 x P 340 mm

---

---

# KORAME

---

design **Roy Frame**

Raffinata collezione di accessori in ecopelle bianca, nera o marrone, con eleganti cuciture a vista.

*A sophisticated collection of accessories in white, black or brown faux-leather, with elegant visible seams.*

---



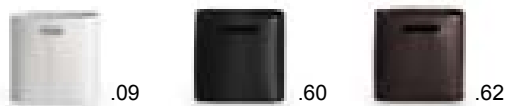

---

**7001** Portariviste /  
*Newspaper container*  
L 375 x H 355 x P 165 mm

---

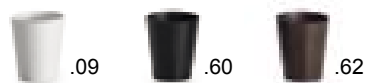

---

**7003** Cestino /  
*Paper basket*  
Ø 225 x H 250 mm

---



---

**7005** Porta salviette /  
*Tissue container*  
L 260 x H 90 x P 130 mm

---

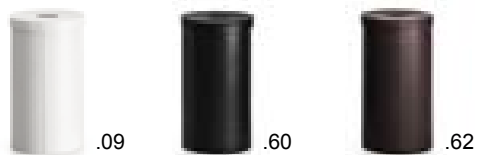

---

**7006** Portabiancheria /  
*Laundry basket*  
Ø 310 x H 555 mm

---



---

# TAPEI

---

Per camminare scalzi e comodi su trame di cotone spesse e ricercate o farsi massaggiare da essenze orientali, teak e legno di rosa con una struttura composta da listelli di legno cuciti con filo di nylon.

*To walk barefoot and comfortably on thick and sophisticated cotton patterns or be massaged by oriental essences, teak and rose wood, by a structure built from wooden strips sewn together with nylon string.*

---

**7215** Tappeto  
*Bath mat*  
L 1000 x H 8 x P 550 mm



**7217** Tappeto  
*Bath mat*  
L 1000 x H 8 x P 550 mm



**72121** Tappeto  
*Bath mat*  
L 1000 x H 8 x P 550 mm



**72123** Tappeto /  
*Bath mat*  
L 1000 x H 8 x P 550 mm



---

# GHEGHE

---

Linea corpo a base di tè verde, i cui ingredienti provengono da coltivazioni che seguono i principi della cultura biologica. Prodotti completi e naturali.

*A line of green-tea based body products, with ingredients from farms that follow the principles of organic farming. Complete and natural products.*

---



---

**4490** Bagno doccia 500 ml (6 pezzi) /  
*Shower bath 500 ml (6 pieces)*

---



---

**4491** Latte corpo 250 ml (6 pezzi) /  
*Body milk 250 ml (6 pieces)*

---



---

**4492** Sapone mani 250 ml (6 pezzi) /  
*Handsoap 250 ml (6 pieces)*

---



---

**4493** Crema mani 75 ml (6 pezzi) /  
*Hand cream 75 ml (6 pieces)*

---

---

## FINITURE / FINISHING

---

### Bambù / *Bamboo*

---

**.03** Bambù naturale /  
*Natural bamboo*



**.09** Bambù sbiancato /  
*Whitened bamboo*



### Mattstone / *Mattstone*

---

**.26** Mattstone /  
*Mattstone*



### Metallo / *Metal*

---

**.09** Metallo bianco /  
*White metal*



**.15** Metallo arancio /  
*Orange metal*



**.11** Metallo rosso /  
*Red metal*



**.16** Metallo fucsia /  
*Fuchsia metal*



**.14** Metallo ruggine /  
*Rust metal*



**.17** Metallo antracite /  
*Dark grey metal*



## Vetro / Glass

---

**.17** Vetro antracite /  
*Dark grey glass*



**.83** Vetro bianco /  
*White glass*



**.29** Vetro foglia argento /  
*Silver leaf glass*

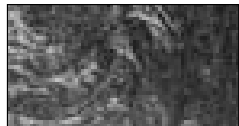

**.85** Vetro nero /  
*Black glass*



**.30** Vetro foglia oro /  
*Gold leaf glass*



**.87** Vetro rosso /  
*Red glass*



**.80** Vetro trasparente /  
*Clear glass*

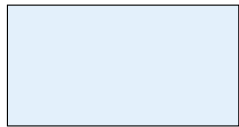

**.89** Vetro ghiaccio verde /  
*Green ice glass*



**.81** Vetro acidato /  
*Etched glass*

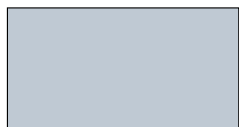

**.91** Vetro Ming white /  
*Ming white glass*



# Lineabeta®

## Lineabeta SpA

36053 Gambellara VI - Italy

Strada Statale 11, Km 331

Tel +39 0444 644644

Fax +39 0444 644600

info@lineabeta.com

www.lineabeta.com



Art work: **JoeVelluto Studio (JVLT)**

Photo ambiances: **Beppe Calgaro**

Photo still-life: **Varianti.it**

Printed in Italy: **Chinchio**

Ed.: **06/2012**

Cod.: **XCA25**

## Uno speciale ringraziamento / A special thank to

**Diamante Beghetto** | Illustrator | Bassano del Grappa | Italy

**Eddy Antonello** | Prototyper | Camisano Vicentino | Italy

**Enrico 'Kali' Dalle Carbonare** | Graphic & Dj | Schio | Italy

**Gianluigi Marchetto** | Entrepreneur | Arzignano | Italy

**Marco Chiurato** | Artist | Marostica | Italy

**Sice Spa** | Zermeghedo | Italy

**Silvano Marchetto** | Entrepreneur | Arzignano | Italy

**Studio Rocchi & Associati** | Architects | Verona | Italy

