

AN·TRAX IT

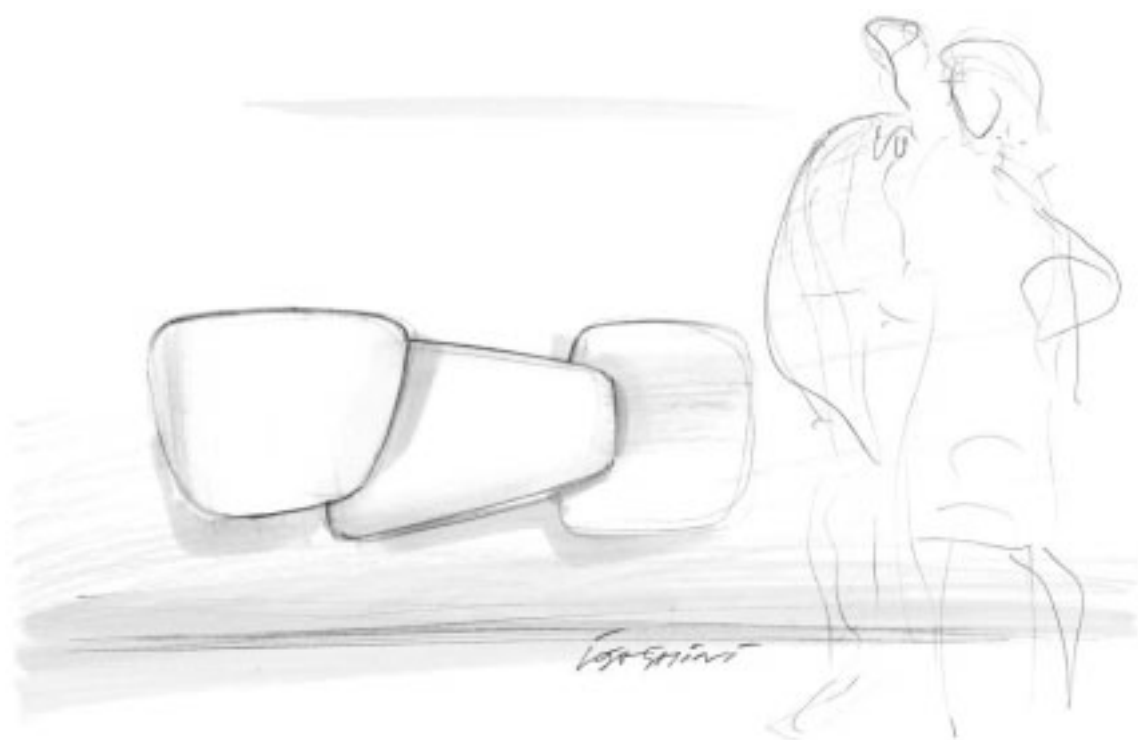

20
12



Scudi

DESIGN MASSIMO IOSA GHINI

La forma riprende i movimenti di uno scudo le cui linee si concretizzano in un design elegante e dalla spiccata originalità. La possibilità di essere installato sia in verticale che in orizzontale, conferisce a questo radiatore una non comune versatilità di posizionamento in cui il senso di stabilità e di sobrietà è mantenuto da un equilibrato controllo di forma e proporzioni.

Scudi è costituito da tre elementi formati da una piastra in acciaio dall'originale forma trapezoidale curvata, possono essere ruotati e scambiati tra loro come scudi che si intersecano e si sovrappongono.

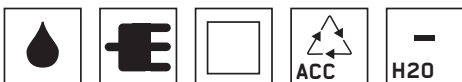



GRIFFE / SCUDI

DESIGN MASSIMO IOSA GHINI

173 x 72 CM

WATT ΔT 50° [939]

COLOR : BRAG

INFORMAZIONI TECNICHE/ TECHNICAL
DETAILS/ DONNÉES TECHNIQUES /
TECMISCHE DATEN / INFORMACIONES
TÉCNICAS : PAGE 222



The shape reflects the movement of a shield, an elegant, truly original design. Installation can be either vertical or horizontal, a feature that makes this radiator particularly versatile, where a sense of stability and sobriety is maintained by the balance between shapes and proportions.

Scudi is composed of three steel plate elements with an original curved, trapezoid shape; they can be rotated and interchanged like overlapping shields that cross.

La forme reprend les mouvements d'un bouclier dont les lignes se concrétisent dans un design élégant et à l'originalité marquée. La possibilité d'être installé aussi bien verticalement que horizontalement, donne à ce radiateur une versatilité de positions qui n'est pas commune où le sens de stabilité et de sobriété est maintenu par un contrôle équilibré de la forme et des proportions.

Scudi est constitué de trois éléments formés d'une plaque en acier d'une forme courbe trapézoïdale et originale qui peuvent être tournés et échangés entre eux comme boucliers qui se croisent et se superposent.





Die Linienführung ruft die Form eines Schutzschilds in Erinnerung, dessen Linien ein elegantes und äußerst originelles Design ergeben. Dadurch, dass der Heizkörper sowohl senkrecht als auch waagrecht montiert werden kann, genießt dieses Modell über eine überaus ungewohnte Vielfalt von Positionierungsmöglichkeiten, wobei Stabilität und Schlichtheit durch eine ausgewogene Kontrolle der Formen und Proportionen gewährleistet wird. Scudi besteht aus drei Elementen, die sich aus einer originellen, trapezförmigen, leicht gekrümmten Stahlplatte ergeben. Wie Schutzschilder, die sich kreuzen und überlappen, können sie gedreht und untereinander ausgetauscht werden.

La forma recupera los movimientos de un escudo cuyas líneas se concretizan en un diseño elegante y de destacada originalidad. La posibilidad de instalarlo tanto en posición vertical como horizontal otorga a este radiador una no común versatilidad de emplazamiento en el que el sentido de estabilidad y de sobriedad se mantiene gracias a un equilibrado control de forma y proporciones. Scudi cuenta con tres elementos, formados por una placa en acero que presenta una original forma trapezoidal curvada, que se pueden girar e intercambiar entre ellos como escudos que se entrecruzan y se sobreponen.













Informazioni tecniche

Technical details

Données techniques

Tecnische Daten

Informaciones técnicas

	<p>Elektrico <i>Electrical</i> <i>Electric</i> <i>Elektrische</i> <i>Electrico</i></p>
	<p>CL2 - Doppio isolamento <i>Double isolation</i> <i>Double isolation</i> <i>Doppel Isolierung</i> <i>Doble aislamiento</i></p>
	<p>Acqua calda <i>Hot water</i> <i>Eau chaude</i> <i>Warm Wasser</i> <i>Agua caliente</i></p>
	<p>Alluminio <i>Aluminium</i> <i>Aluminium</i> <i>Aluminium</i> <i>Aluminio</i></p>
	<p>Acciaio al Carbonio <i>Carbon steel</i> <i>Acier au carbone</i> <i>Carbon Stahl</i> <i>Acero de carbono</i></p>
	<p>Pronta consegna <i>Stocked item</i> <i>Produit stocké</i> <i>sofortige Lieferbar</i> <i>En estoc</i></p>
	<p>Alta efficienza termica <i>High degree of thermal efficiency</i> <i>Haute efficacité thermique</i> <i>Hohe Heizungsfähigkeit</i> <i>Alta eficiencia térmica</i></p>
	<p>Basso contenuto d'acqua <i>Limited water content</i> <i>Volume d'eau réduit</i> <i>Niedriger Wasserinhalt</i> <i>Reducido contenido en agua</i></p>

Blade	232
Flat	226-227
Hiti	246-247
Loft	230-231
Moon	233
Oreste & Emma	229
Saturn	233
Serie T	236-245
Scudi	222
Teso	235
Treo	228
Tubone	224-225
Vu	223
Zero-otto	234



Scudi DESIGN MASSIMO IOSA GHINI

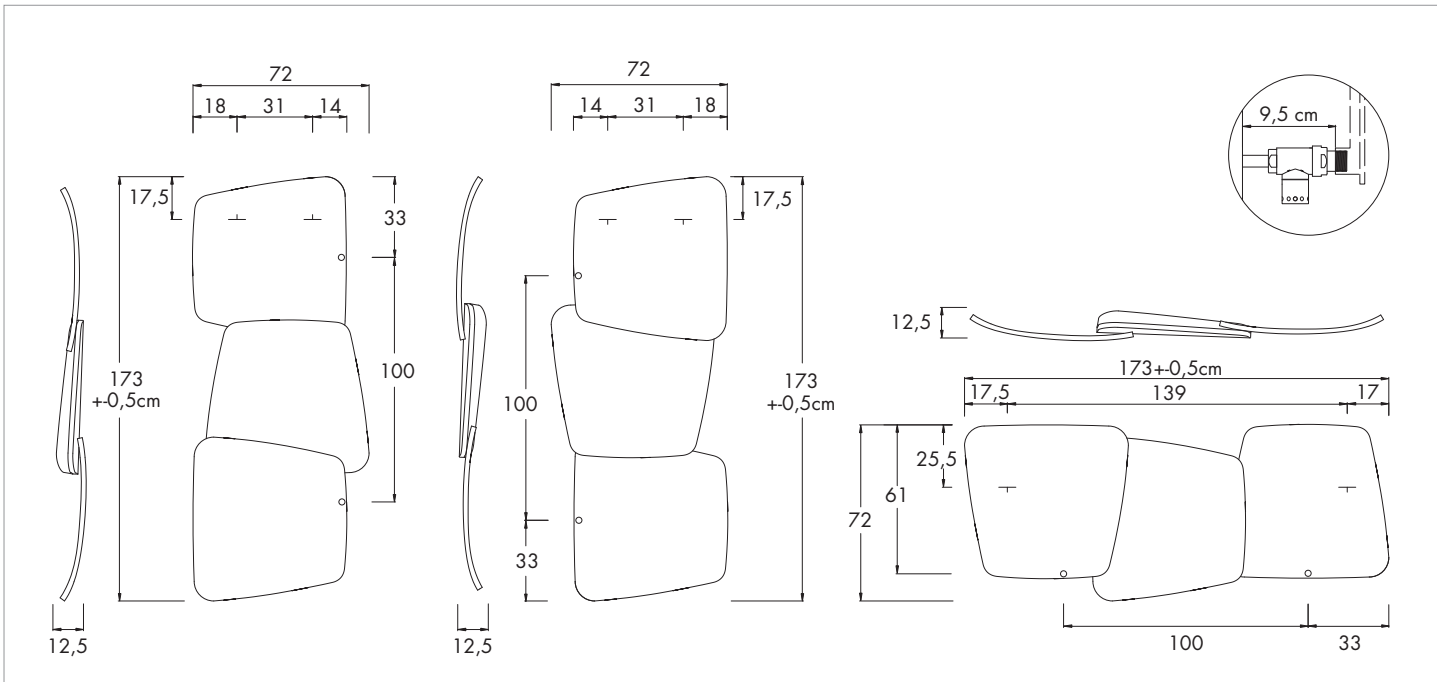
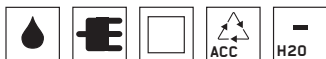

A* cm	in	B* cm	in	l* cm	in	art*	BTU Δt 50°	watt Δt 50°
verticale / vertical / verticale / vertikal / vertical								
173.0	68.1	72	28.3	100.0	39.4	SC00V03B	3 174	939
orizzontale / horizontal / horizontale / horizontal / horizontal								
acqua calda / hot water / eau chaude / warm Wasser / agua caliente								
72.0	28.3	173.5	68.3	100.0	39.4	SC00O03B	3 174	939
elettrico / electrical / électrique / elektrische / eléctrico								
72.0	28.3	173.5	68.3	100.0	39.4	SC00O03EB		1 080

A* = altezza / height / hauteur / Höhe / alto B* = larghezza / width / longueur / Breite / ancho art* = articolo / model / modèle / Artikel / artículo P* = pagina / page / page / Seite / página
 l* = interasse / pipe centres / distance entre depart et retour / Achsabstand / distancia entre las conexiones



Ulteriori dettagli
Further details
Ultérieures détails
Weitere Einzelheiten
Otros detalles

P* 318

Colori/ colours / couleurs / Farbe / colores

- [BIAN] B standard
- T + 10%
- S + 20%
- [RAL] S + 20%
- RAL non inclusi in tabella
- special Ral colours
- couleurs Ral spéciales
- RAL Farbe nicht in der Tabelle inbegriffen
- colores RAL especiales

Kcal = Watt x 0,860
BTU = Watt x 3,413

Watt Δt 60° = Watt Δt 50° x 1,256
Watt Δt 40° = Watt Δt 50° x 0,757
Watt Δt 30° = Watt Δt 50° x 0,529
Watt Δt 20° = Watt Δt 50° x 0,319

p max = 10.0 bar

ANTRAX IT SRL
VIA BOSCALTO 40
31023 RESANA TV - ITALY
TEL. +39 0423 7174
FAX +39 0423 717474
WWW.ANTRAX.IT
ANTRAX@ANTRAX.IT

CONCEPT: Alberico Crosetta
GRAFHC: Alberico Crosetta
PHOTO: Quasarfoto
PRINT: Ditte Artigrafiche [04/2012]

THANKS TO:

Catellani & Smith
Hoesch
B-mood
Antrax Hellas LTD
Luca Tessarin
Walter Mentil
Tillen Zbona
Valentina Meli
Borsa di Milano
Hotel les Fleurs

